

RADIO TODAY

51 Yearly

Caldwell-Clements, Inc., 480 Lexington Ave.

New York City

RADIO Will Elect the Next President

Political Buzz

- getting public ready for June conventions
- listeners eager
- new models in May
- office radio sets

Auto Radio

- new lines out
- visual tuning
- metal-tube sets

Price Evils

- N. Y. situation
- chains vs. department stores
- Cortlandt street

Through the Laboratory Keyhole

- flat receivers
- facsimile
- television

Servicing

- modern antennas
- repairing flood-damaged sets
- circuits interpreted

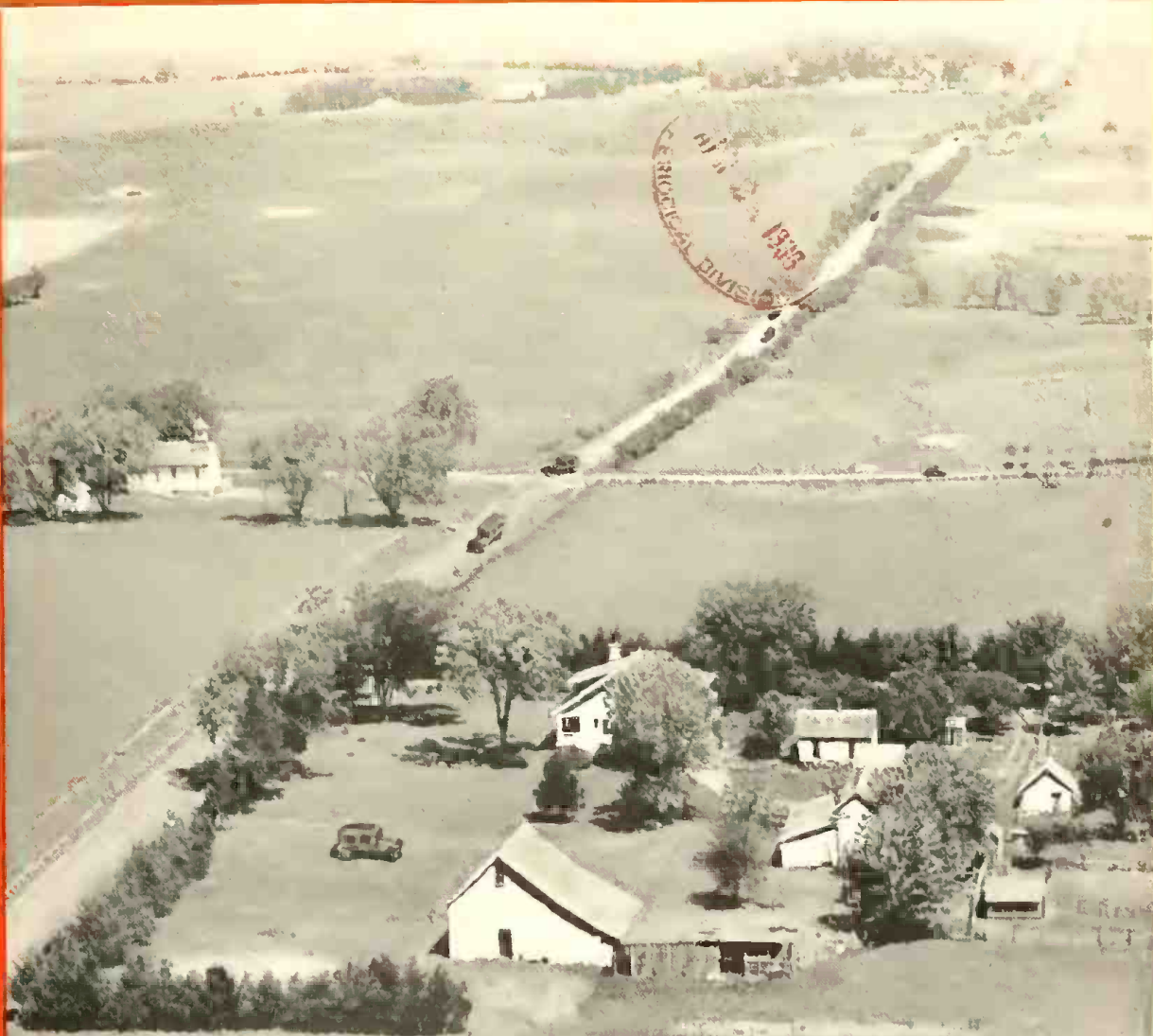

FARM RADIO
AUTO RADIO

Biggest unsaturated markets for 1936

APRIL
• 1936 •



Dealer: "Yes, that's my favorite program, too. But have you ever heard it on this particular set?"

Woman: "No, I haven't."

Dealer: "Then honestly—you'll hardly believe your own ears!"

Finer Programs . . .

the final intimate link in selling the better radio sets!

Keep yourself informed on the National Broadcasting Company's star programs . . . they help make sales!

People react warmly to the subjects with which they are familiar. And their main interest in their radio is its ability to give them the best possible reception of their favorite programs.

Of course, they know all about the features, tone, finish and price

of your better sets. You've covered those points, and now they are debating inwardly. That's the time to bridge what is often an awkward gap in the making of a sale. The mention of an NBC program has provided the final link in many a sales chain to a better radio.

The broadcasting system and the interests of the 15,000 dealers who contact and sell four to five million listeners a year are closely bound

together. Use National Broadcasting programs to demonstrate receivers, and swing your sales to a better type of instrument!

Service Men, Too!

When you are making check-ups, recommending repairs and replacements, draw your customers' attention to the better reception they'll get with new accessories. Stress NBC's finer programs.

Tune in the RCA Magic Key Program every Sunday 2 to 3 P. M., E. S. T., on the NBC Blue Network

NATIONAL BROADCASTING COMPANY, INC.

A Radio Corporation of America Service

NEW YORK

WASHINGTON

CHICAGO

SAN FRANCISCO

PLAY UP PANELS!



*it's the short cut
to car-radio sales*

LESS than a \$10. bill sets you up in the car-radio business this season! That's the price of the American-Bosch Custom Panel Display...complete with 7 custom-styled panel mountings that serve 88% of new cars on the road!

It's the smartest selling idea of the year! Set it in your window, or shop, or out in front! Its flashing colors lure the prospect...he sees the actual panel that matches the very car he drives...he can't resist the appeal to play with it...ask you questions...sell himself into a set!

This panel display is the final touch to the unapproached combination offered by American-Bosch Skylark Car-Radio:

- An entirely new conception in chassis design—the double-winged chassis that achieves as much for car-radio performance as the CentrOmatic Unit did for the American-Bosch Home Radio.
- Any type of speaker the customer wants; built-in, overhead or bulkhead.
- Custom-styled panel mountings.
- Metal tube sets or glass tube sets.
- A price range from \$39.95 to \$67.95.
- The American-Bosch Motor-Matic Antenna, for best results in cars not equipped with a roof antenna.

Write or wire for new broadside that tells the whole story...including the colorful, all metal portable demonstration stand...cloth banners and window streamers that sing the Spring song of gaiety...everything you need to compete successfully this season!



AMERICAN-BOSCH SALES MAKER PANEL DISPLAY

Contains custom-styled panel mountings for 88% of new cars on the road! Displayed in this flashing kit of red, blue, black and white plus the beautiful finish of panels with their colored controls. Size: only 19" x 18½" x 5". Provided with stock storage space below. Complete with substantial metal easel, seven panel kits with panels and knobs mounted ready for display. Costs nothing beyond cost of panels. List price \$9.80.



MODEL 736—7 metal tubes, and exclusive double-winged **\$59.95** chassis illustrated at left (Other models from \$39.95 to \$67.95.)

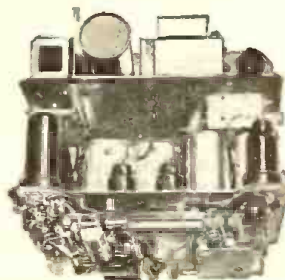

UNITED AMERICAN BOSCH CORPORATION, SPRINGFIELD, MASS.

New York Chicago Detroit

AMERICAN-BOSCH Skylark CAR-RADIO

It's NEW . . . It's TOPS in Alternating Current!

Emerson Radio

"RE-CREATES THE ARTIST

IN YOUR HOME"



Model 107-AC in the Famous DUO-TONE Cabinet
Same grille front and back. High grade matched American Butt Walnut with Mahogany inlay and Ebon base. Hand rubbed finish. 10 3/4 inches high.

It scored an immediate success. Overnight it became the "bell wether," the leader, in hundreds of stores. It has EVERYTHING in STYLE, POWER, TONE and VALUE which make any set outstanding. It's the NEW . . .

EMERSON . . . Model 107-AC
(For Alternating Current)

AMERICAN, POLICE and FOREIGN

5-Tube A C Superheterodyne — with Two Double-Purpose Tubes . . . 3 Watts Output . . . Illuminated "Edge-Glo" Dial . . . Emerson "Micro-Selector" . . . Automatic Volume Control . . . Tone Control . . . DUO-TONE Cabinet.

It has the power of a big set — the TONE of a console — the price of an ordinary compact — and it carries the FULL DISCOUNT. Already it has piled up records which indicate a long-time popularity. List price, with RCA tubes,

\$39.95

(Slightly Higher in West and South)

Another EMERSON "Hit" Making Sales Records . . .

EMERSON Model 118. Meeting low-price competition with really fine design and outstanding performance — at a price which gives the buyer confidence and the dealer a reasonable profit.

AC-DC. 5-Tube TRF, including METAL Ballast Tube . . . Receives Standard American Broadcasts and Low Frequency Police Calls . . . Illuminated Areoplane Dial . . . Litz-Wire Coils . . . Electro Dynamic Speaker . . . Built-In Aerial . . . Straight Grain Walnut Cabinet—front panel of Syroce-wood, carved design. 10 inches wide.

\$14.95

(Slightly Higher in West and South)



The Complete Emerson Line Ranges from \$14.95 to \$129.95 . . . Send for Details

EMERSON RADIO & PHONOGRAPH CORPORATION, 111 Eighth Avenue, New York, N. Y.
The EMERSON Line Also Comprises Models for Every Foreign Market • Cable Address: EMPHONOCO, N. Y.

The March of Tubes!



Millions of Raytheons in the Homes of America...

AS TIME MARCHES ON—so Raytheon tubes literally by millions, pour from the factory to set manufacturers and into thousands of homes as initial tube equipment in new sets. The "March" paves the way for almost unlimited replacement sales.

Leading set manufacturers, most critical of buyers, prefer Raytheon quality and performance. Radio engineers endorse them. They are produced with painstaking attention to the minutest detail, under the supervision of research and production engineers second to none in the tube industry.

Today Raytheon dealers and servicemen are capitalizing this established replacement market.

Raytheons are easy to sell because they give such dependable service as original equipment.

A COMPLETE LINE—for every replacement purpose—4-Pillar Glass with standard and octal bases and genuine All-Metal types. Ask for the latest Raytheon catalog and technical information.

RAYTHEON PRODUCTION CORPORATION
30 E. 42nd Street, New York
555 Howard Street, San Francisco, Cal.
445 Lake Shore Drive, Chicago, Ill.
55 Chapel St., Newton, Mass.
415 Peachtree St. N. E., Atlanta, Ga.

RAYTHEON

TRADE-MARK

Just off the Press! ... the PHILCO POLITICAL RADIO ATLAS

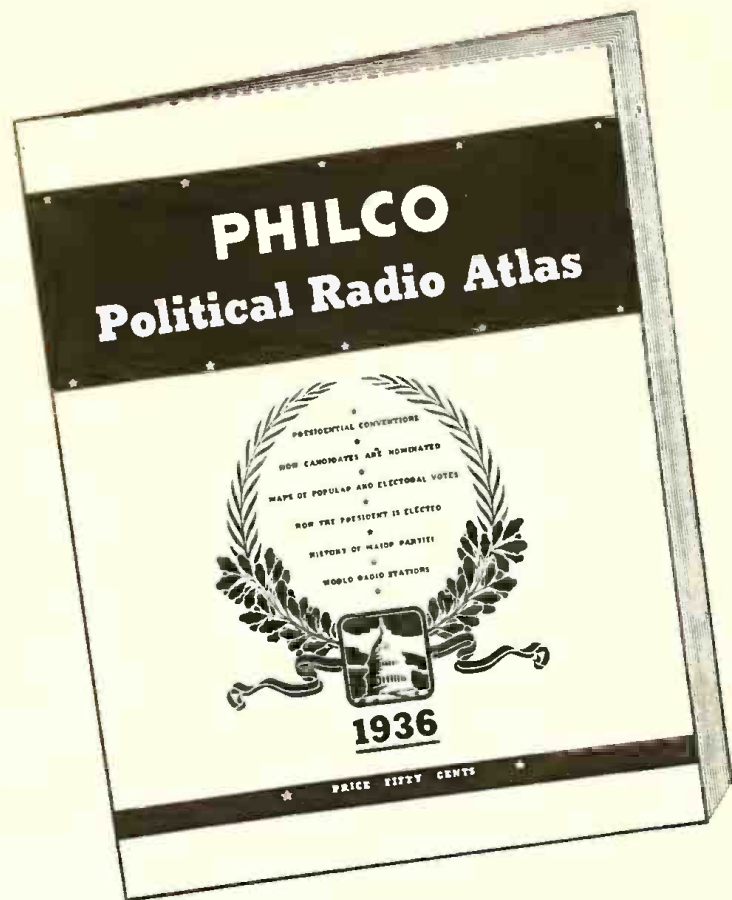

*a big, new, profitable
promotion idea for
April and May—*

FOR YOUR STORE!

★

- ★ The first and only book of its kind!
- ★ Absolutely new and different!
- ★ Fits large and small stores alike!
- ★ Gives you the jump on competition!
- ★ Builds up your store traffic!
- ★ Boosts your Philco sales and profits!
- ★ Piles up points for the Philco Cruise!

THE political pot begins to boil! The air waves are filled with a wealth of political speeches and news! And Philco enables its dealers to CASH-IN on the tremendous interest in "Politics On The Air" . . . with a big, illustrated book every radio listener will want!

The Philco Political Radio Atlas . . . size 10" x 13" . . . printed in colors . . . is packed full of stories and photo-

graphs. It gives advance information on the Republican and Democratic conventions . . . histories of the major parties . . . maps showing electoral votes . . . world radio logs, etc., etc.

It's a big, new, profitable sales help that means **BUSINESS FOR YOU!** Get in touch with your Philco distributor at once . . . see this wonderful promotion piece . . . and be sure to get a supply **NOW!**

PHILCO RADIO & TELEVISION CORPORATION

Staff—

DARRELL BARTEE
 RANDALL R. IRWIN
 G. H. MAYORGA
 M. H. NEWTON
 B. V. SPINETTA
 VINTON K. ULRICH

LEE ROBINSON
Sales Manager

RADIO TODAY

ORESTES H. CALDWELL
Editor

M. CLEMENTS
Publisher

480 Lexington Ave.
 New York City
 Tel. PLaza 3-1340

Vol. II, No. 4

FIERCE CHANGES ARE OUT

★ Erstwhile movement in the N. Y. *Times* business index — now at high levels — shows no savage twists either way, and most of the trade elements reveal a pleasant and steady tendency to hold their own. Flood disasters registered a negative effect upon general activity, but recovery was instant and vigorous.

Auto sales are definitely strong; telephone companies report that they installed more phones last month than at any time in their history. All markets which depend upon summer conditions appear to be headed for a new peak.

Radio trade anticipates a unique and active spring and summer, to supply new consumer buying-power.

"ALL WAVE" DEFINED BY RMA

★ At the public hearing on trade practices for the radio-set manufacturing industry, held by the Federal Trade Commission at Washington, D. C., April 6, definitions were offered by the Radio Manufacturers Association for "standard broadcast band," 540 to 1600 kc.; and "all wave," 540 to 18,000 kc. (16.65 meters).

In the merchandising or advertising of all other radio receivers having less than continuous coverage from 540 kc. to 18,000 kc., "failure to detail specifically, either in kilocycle bands covered or in description of broadcast services covered by such receiving sets in accordance with below-detailed definitions recognized by the Federal Communications Commission, shall be an unfair trade practice."

	Kilocycles
All-Wave	540 to 18000
Standard Broadcast (American, Standard or Domestic)	540 to 1600
Night-time Foreign:	
At least 2 of the following 3 bands	{ 6020 to 6140 9510 to 9590 11710 to 11890
Daytime Foreign:	
At least 2 of the following 3 bands	{ 11710 to 11880 15110 to 15330 17760 to 17800

Foreign (Unqualified) Must include Night-time and Daytime as defined.	
State Police	1608 to 1712
Municipal Police	2308 to 2492
Police (Unqualified) Must include both State and Municipal as defined.	
Night Aviation: At least 2 of the following bands	{ 2612 to 2648 2732 to 2748 3082, 4110, 4785
Day Aviation: At least 2 of the following bands	{ 5375 6510 to 6600 8015, 16240
Aviation (Unqualified) Must include Night and Day	
Second-class Amateur	1800 to 2000
First-class Amateur, Night	3900 to 4000
First-class Amateur, Day	14150 to 14250

FOR SAVAGE BREASTS

★ Joyous observance of National Music Week, beginning the first Sunday in May and having the nature of a United States festival of song, will again glorify the musical accomplishments of thousands of communities throughout the nation. Dedicated to the proposition that "any song is music which bespeaks a singing heart," the action committee is appropriately headed by a radio man, RCA's David Sarnoff.

Nearly 5,000 units of the National

Federation of Music Clubs will be in on the festival; schools, churches, counties, clubs, industrial groups, hospitals, and hundreds of bands and orchestras will be celebrating. Throughout the week the broadcasters will air a series of impressive features.

RADIO'S NEW RALLY

★ Aside from the political tonic being administered to general radio activity, a curious set of circumstances has appeared to make Spring and Summer volumes feel a steady lift. Influence of political conventions, set for June 9 and June 23, was barely under way when the broadcasters announced plans for important airings of sport events of international interest — Olympic games, championship prize fights, and derbies.

Farmers, whose incomes this year seem likely to reach 9 billion, but whose destinies are tied up in the coming election, take this chance to develop a natural flair for politics, via the radio in a possible 6,800,000

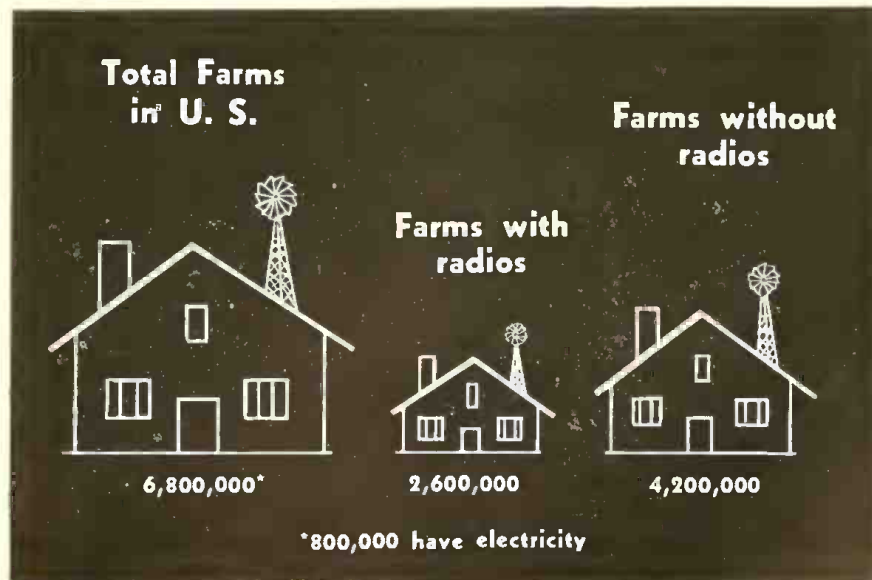



Spring-season at GE importantly opened with a gala midday broadcast, star-studded. Speakers included Vice-President C. E. Wilson, President Gerard Swope, and general sales manager P. B. Zimmerman.

homes. Thus for radio's relish is the U. S. Department of Agriculture's statement that the farm population is now the largest in the nation's history — 33,000,000. Impressive also is the latest total on the value of farm property, \$57 billions.

POLITICIANS STAGE CLIMAX

★ Blaze of business which is promised radio at election time already falls as a deep glow on 20,000 dealers; even now the listener-millions flock to their sets to hear broadcast news of political developments. Eagerly and one by one, significant units of the industry interest themselves seriously in the comfortable fact that "radio elects the president." For the early relish of dealers and servicemen comes the initial climax period, the political conventions: Republicans, June 9; Democrats, June 23.

Shrewd plug in April 4 edition of the *Saturday Evening Post* carries a tingling summary of what politics means to set selling in 1936:

"Cleveland in June! The dramatic moment when the Republican party selects its Presidential candidate. Each nominating speech inspires a tumultuous demonstration. Radio announcers speaking above the uproar describe the scene . . . call of the state standards paraded for each nominee. Now the balloting begins! In alphabetical order the roll-call of states gets under way. Will it be Hoover . . . Borah or Knox? Landon or some dark horse? Admission to the convention will be at a premium . . . but through Philco you can attend every session . . . catch all the fervor of nominating speeches . . . time the length of each demonstration."

EUROPE'S PROBLEM-PROGRAMS

★ Short-wave radio buzzed and sputtered its way into European diplomatic circles recently, after Herr Hitler had told the world what it could do with another treaty. Stations of four nations were busy broadcasting their own ideas 24 hours a day; total airings were 55 daily.

The upsetting thing about the situation was that nations could check up on their neighbor's views, via radio, before any formal diplomatic exchanges were made. The European stuffed shirts, ha ha, stood stripped

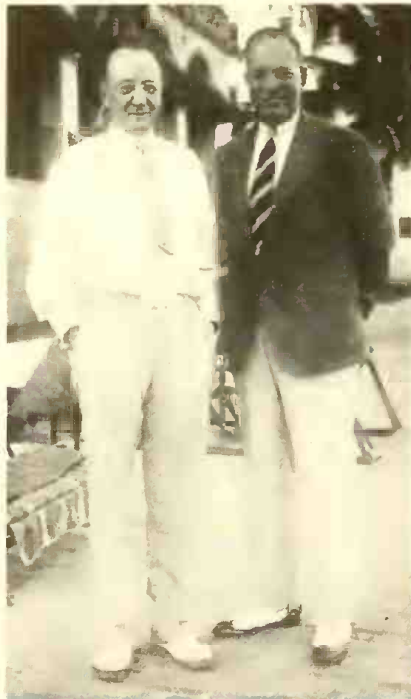

Hygrade smiles. Sylvania's president, B. G. Erskine, on his Florida rest, hears C. G. Pyle's report on record tube sales.

of their thin ceremonies and their red tape; diplomatic etiquette went into a laughable loop as ministers, deputies, dictators and ambassadors saw their petty routines thrown into a total tangle.

Short Wave Institute of America, at Washington, D. C., checked up on the goings-on and remarked with a certain cunning that "as a result of the race, government news broadcasts of many important developments reached the public before the opposing diplomats could proclaim their own versions."

RADIO ADVERTISING IN NEWSPAPERS

★ Records of newspaper advertising in 369 newspapers in 95 principal cities, compiled by Media Records, Inc., show the following as the number of lines of newspaper ads run by radio manufacturers during 1935:

Sets	Lines
Arvin	8,476
Atwater-Kent	102,903
Bosch	17,247
Crosley Radio	3,074,23
Delco Radio	4,239
Emerson	7,184
Fairbanks-Morse	7,927
General Electric Radio	676,444
Grunow Radio	48,441
Midwest	37,155
Motorola	14,239
Philco Radio	2,428,723
R.C.A.-Victor Radio	545,807
Royale	5,206
Sparton	17,433
Stewart-Warner Radio	77,746
Stromberg-Carlson	51,770
Westinghouse Radio	51,820
Zenith	169,152
Total. Sets	4,379,340

DEATH ON THE DIAL

★ Fierce disorder in the life of a young Hungarian composer, Reszo Seress, moved him to write a dark and desperate song called "Szomorú Vasarnap." Radio listeners know it as the enormously popular "Gloomy Sunday" sensationally promoted here as a Hungarian suicide song which the Budapest police had to ban because 18 people killed themselves over it.

Recently, a Columbia Records scout found an old friend of Seress' singing away in a New York night club, and invited him to make a Hungarian recording. This singer got through it OK, but when Hal Kemp and his orchestra tried to make the other side of the record, twenty-two waxes were ruined trying to get the morgue-like mood. Finished record is a deathly one.

Watch the papers for further suicides.



Fairbanks-Morse's new radio sales manager, Parker H. Ericksen.

SERVICEMEN'S BIG SHOW

★ Liveliest radio confab in the last 5 years was the IRSM Fourth Annual Convention and Trade Show, which wound up March 29th in Chicago. Servicemen, jobbers, manufacturers, and manufacturers' representatives swarmed in from all states to boost the attendance to over 5,000.

Probably outstanding feature of the three-day gathering was remarkably large attendance of jobbers. Some came from Pacific Coast; others from distributing centers in Northwest, Southwest, and Central states. Jobbers showed keen interest in exhibits that constituted an important part of the trade-show program, and the Hotel Sherman Convention Hall often resembled a consumer show from point of attendance.

It was apparent that jobbers are planning intensive merchandising campaigns this coming season in behalf of radio parts of all descriptions. Manufacturers' representatives closed many important connections during the three-day show and the thousands of servicemen who visited the Hotel Sherman were amply repaid for the time expended by a practical, constructive program that went through smoothly from start to finish.

New president of IRSM is John T. Rose, Endicott, N. Y.; vice-president is Harold Nitze of Sheboygan, Wis. Joseph E. Kamys was re-elected secretary-treasurer and Ken Hathaway was re-elected executive secretary. To Mr. Hathaway and his associates be-

longs credit for one of the most successful trade gatherings that has taken place in the radio industry for many years.

AUTO RADIO OPPORTUNITIES

★ Number of rural mail routes in the country is 34,858, each with a lonely driver.

There are 70,500 motor buses in the U. S. being used by consolidated schools.

In the 48 states there are 4,134,675 farmers who own cars. They buy 26 per cent of all trucks manufactured.

Fleet owners in the U. S. number 25,975, operating 772,000 motor trucks.

There are 45,000 buses in regular revenue service.

WALL OF WATER

★ Dramatic devotion to public service which prompted radio to take a spectacular part in the flood crisis is seen in the reports of Transradio Press Service. Here is what happened among its broadcast station clients in the high water areas.

WBRE devoted 95 per cent of its time to flood bulletins; WHP reported minute-to-minute develop-

ments as the waters came up; WGBI completely disregarded regular news periods in response to constant audience demands; WEST went on the air almost continuously with flashes and used regular news periods for summaries of flood conditions; WEEU used as many as six 5-minute periods of flashes within an hour; WBNY went in for a constant flow of flood bulletins and reported a record breaking number of phone calls; WNBF went on the air at the beginning of the emergency and stayed on for 66 hours.

Other stations doing fine work were WHDH, WCOP, WLVA, WSPA, and WSOC. Many of these stations and others immediately hooked up with the Red Cross to assist in relief measures.

RADIO DATES AHEAD

Institute of Radio Engineers, annual convention, Cleveland, Ohio, May 11, 12, 13.

Republican National Convention, Cleveland, Ohio, June 9.

Radio Manufacturers Association, annual convention, Hotel Stevens, Chicago, Ill., June 18-19.

Democratic National Convention, Philadelphia, Pa., June 23.

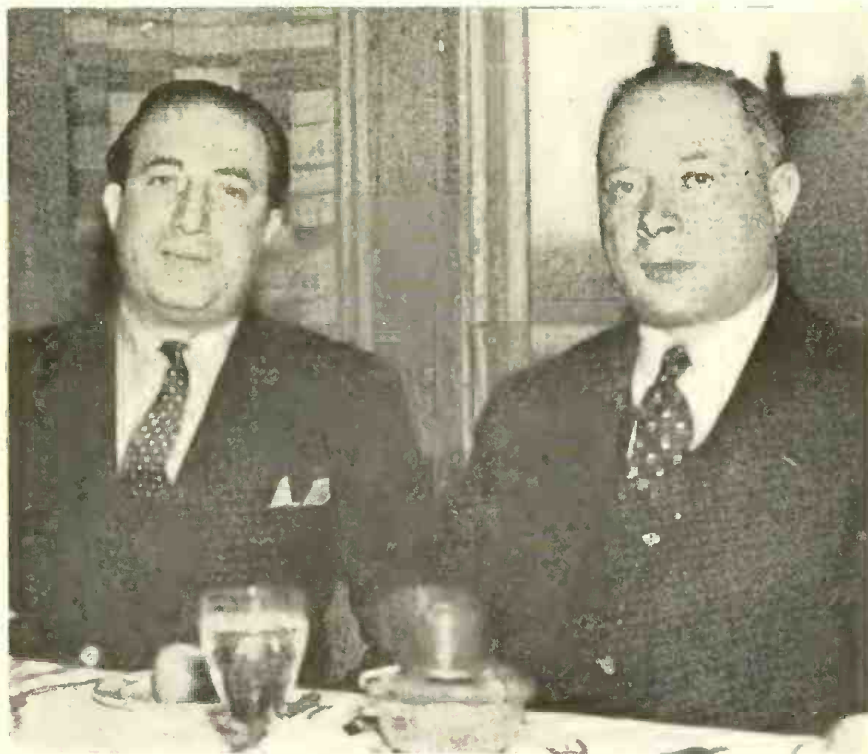

As chairman National Music Week, David Sarnoff (right) president RCA, will open nation-wide celebration May 3. With Mr. Sarnoff is Donald Flamm, president WMCA, New York. Broadcasters like the Week's to-do.

NEW YORK—RADIO'S CANCER SPOT!

- price evils of Manhattan's "profitless selling" inoculate whole trade
- three-sided battle-royal between chain, department stores, and Cortlandt St.
- manufacturers helpless singly; too busy "special-dealing" to combine for reforms

★ CAPTAIN KIDD once had his pirate headquarters in the Hudson River near the foot of Cortlandt Street, New York.

The infamous Captain is no more. But he has been succeeded by a mighty swarm of bold buccaneers who fly a similar flag and exhibit the same devilish glee at scuttling a ship or slitting a throat. But this time it is an improved form of piracy, loosely referred to as "the radio trade" of New York City.

* * *

New York—with its surrounding 50-mile radius—represents the richest radio market in the world. In this unique metropolitan area are sold from 12 to 15 per cent of the radio receiving sets of the nation, with a retail volume that probably aggregates \$35,000,000 to \$40,000,000 annually. For manufacturers, distributors and dealers, this should be a profitable, peaceful and happy situation, offering rich rewards.

Individuals squeezed

Yet, owing to a combination of circumstances in the local radio merchandising set-up, the name of "the New York market" in radio has come to indicate only an eternal "battle royal" in destructive price cutting, with price standards shattered and all elements hopelessly involved in a war without profit. Meanwhile, independent dealers on the sidelines are being slowly squeezed into a state of helpless despair.

With increasing viciousness, the New York cancer eats not only into the vitals of the metropolitan radio market, but it creates far-reaching abuses which are felt all over the country and exert malevolent influences on radio retailers remotely removed from Broadway's glitter. Other cities have their "radio-row" troubles, but in none can be found such incessant violence in price slaughter as goes on all day long in the tight little isle of Manhattan and within sight of the Empire State Tower.

Several factors are involved in the

New York price situation, to wit:

1. A department store which advertises that it will under-sell all other merchants by 6 per cent, and energetically does so.
2. A group of chain-store outlets which sell 50 per cent of the radio retail business in the city.
3. Cortlandt Street—Manhattan's "Radio Row."
4. Radio-receiver manufacturers who fight for local radio volume with discounts that sometimes reach "60 off."

When you mix these together, the results are fairly obvious.

Evils that result

List prices collapse.

Price cuts of 40 to 50 per cent are common.

Average price levels are dragged 25 per cent below list prices.

Cash sales are made for almost any amount offered by bargain hunters.

"Push money" in generous slices is offered by the manufacturers to retail salesmen—1 per cent and 2 per cent of the selling price: fountain pens; bill-folds; watches, etc.

Installment sales are made without interest charges.

Meanwhile the individual radio

MANHATTAN MADNESS, ITEMIZED

Price-cutting, rampant, now means 25% price depression.

Misleading radio ads, deliberately designed for rank deception.

Trade names destroyed, or identified with unprincipled bargain drives.

"Push money" brazenly handed out right and left, to salesmen.

"Volume-phobia" gives cash customers sets at ridiculous prices.

"No-interest" installment selling puts independent dealer on the spot.

dealers, desperate amid such merchandising tactics, try to follow suit in self-defense, but find themselves in a progressively weaker and weaker position.

New prices every hour

Prices of well-known radio models mean nothing amid New York's gilded towers. Hour after hour during the day the quotations on standard makes of sets fall, with the afternoon shadows, as department-store "shoppers" visit each other's sales floors, check up on prices offered, and phone back the figures they find at the moment.

Some manufacturers by patient urging have even succeeded in getting the day opened with list prices tagged on to their goods. But there is one store that takes pride in marking down all competitive prices by 6 per cent. So by 10:30 a.m. when the shoppers from the store with list-price aspirations, come upon the \$94 price on a \$100 article, the first store cuts to \$94 also. Back by return circuit comes the news of this cut, and Mr. Six Per Cent re-prices his standard set at \$94 minus 6 per cent, or \$88.36.

Then, bingo, the competing store adopts this price, and an hour later \$88.36 has become \$83.06 at the "we-undersell-by-6 per cent" emporium. And so it goes on, until by 4:30 p.m. the price level may be down to around \$75. Total result: prices cut below profit levels, manufacturer's good will shot to pieces, everybody losing money.

"Meet competition"

Next day the process begins all over again. On sunshiny mornings, sometimes the start is made at list; other days a few fancy initial cuts are made just to start the hatchet-throwing with a fresh note of deadliness!

With such rare comedies—or tragedies—of pricing taking place daily on department-store sales floors, it is small wonder that the chain outlets seize the chance to "meet competition."

Trade names destroyed

And while this high comedy goes on in the chain and department store outlets in Mid-Manhattan, the 50 or 60 stores which make up "Cortlandt Street" and vicinity, are pulling a few new ones on Jersey commuters and bargain-hunters from Broadway. The tactics of radio row are cunning and picturesque, and worth a story by themselves.

Manufacturers of well-known products suffer more than money loss in this uproar. Trade names are being manhandled and destroyed; famous brands are included in misleading come-on ads which are so shrewdly designed that impressions of even worse price cuts are left with newspaper readers. Even manufacturers of strictly quality lines are not safe on this New York battlefield. The public has grown chiefly price-conscious, and merit of product is now forgotten.

Thus the manufacturers, distributors and dealers find themselves in a foul pit, partly of their own digging.

Certainly the problem could be solved if the manufacturers and distributors would work together and cooperate to purify selling practices. Radio retailers as a whole would welcome this move. It would mean a restoration of prosperous conditions to dealers who have suffered greatly in the past ever-descending circle of price competition.

WAYS TO TREAT THE TROUBLE

Organized huddles among the manufacturers.

Get local distributors to tackle the problem, with serious backing of their factories.

Simple revision of discount levels,— which have now become fictitious, anyway.

Or perhaps a combination of all three above.

Dealers hold whip-hand

But no single manufacturer can effect reforms, or even withdraw from the unfortunate goings-on without the cooperation of all. Any manufacturer who hesitated to condone his share of admittedly offensive policies would lose a substantial part of his New York business, as things stand today. No manufacturer can crusade alone.

And the dealers know this.

Several solutions have been proposed for the New York dilemma. They are presented somewhat warily, because the present system wears

down everybody it touches and has benefits for none.

What's the answer?

1. The manufacturers might bury the hatchet and cooperate in a plan to salvage the price chaos in the New York market.
2. Given backing, the New York radio distributors, who meet monthly, could themselves tackle and solve the bewildering problem of which they are now the victims.
3. Present long discounts might be revised in favor of lesser margins, to discourage the retailer against throwing away his compensation.

Or perhaps a combination of the above might be worked out, by which the local distributors, who are in closest contact with the situation, would obtain the backing of their factories, in the realization that a solution *must be found* or all will perish.

Create more business!

After all, the solution is in the hands of the manufacturers. If they can be convinced that they should work jointly to promote more radio sales in the fertile New York market, instead of madly fighting for existing business, a constructive force will be set in action which will brighten the combined prospects of manufacturer, distributor, and dealer.



New York — with its surrounding 50-mile radius — represents the richest radio market in the world. It absorbs

\$35,000,000 of radios annually — 12 to 15 per cent of the national total, and employs a vast trade army.

LIKELY PLACES TO SELL RECEIVERS

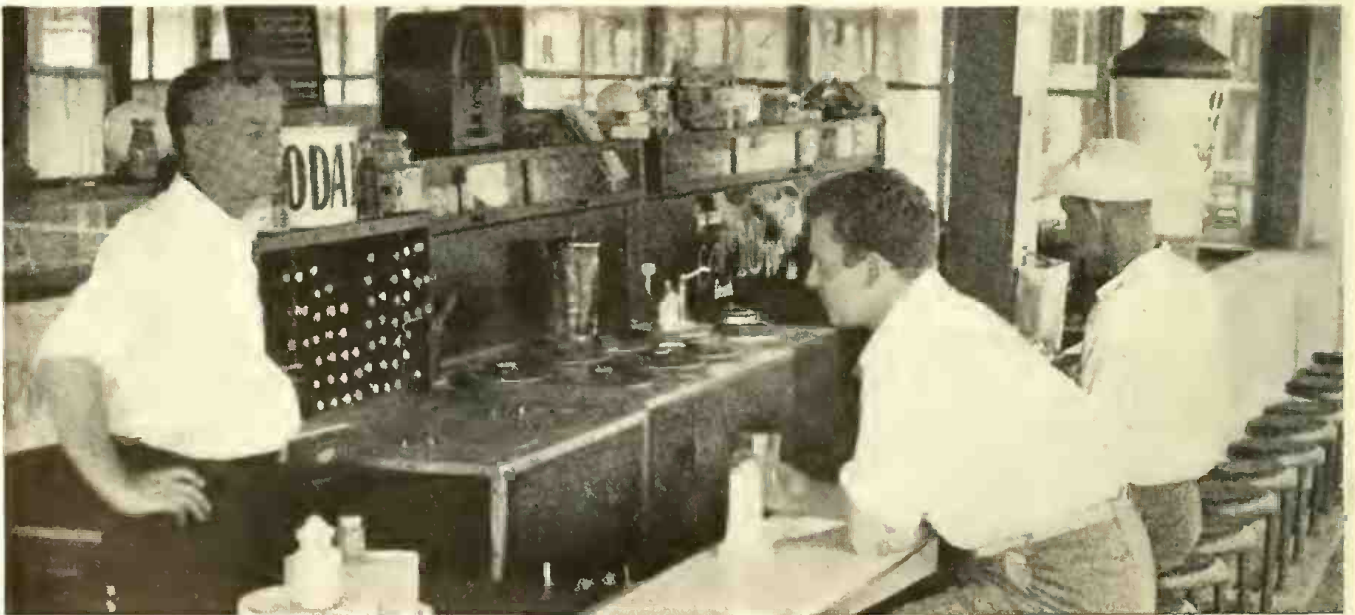

Photos by C. B. S.

CHANCE TO SELL more radio sets exists in many unexpected spots. Besides the beauty parlor, store, fire station and lunch counter, which are shown above, there's a fertile

sales field among barber shops, gas stations, all types of stores, cafes, jails, beer gardens, dance halls, club rooms, hotels, reception rooms, lodges, shoe-shine parlors, etc.

AUTOMOBILE RADIO

- sales booming; may reach 1,750,000 auto sets this year
- automatic-frequency-control to keep driver's eyes on road
- advantage of dealer-marketed sets when owner changes cars

★ **ALREADY** automobile-radio sales are opening up rapidly with good Spring weather, and the total volume of auto-radio sets to be moved this year may approach one and three-quarter millions. While a large number of new cars will come into the hands of their owners already radio-equipped, the big market still remains for the radio dealer and radio service man to install car radios as special customer jobs.

With public and official attention being focussed on reduction of automobile accidents and the promotion of safe driving, much consideration has been given this year to taking the driver's attention away from the road as little as possible. New auto-radio tuning dials have big white-on-black figures, so that the pointer position can be easily glimpsed without taking the eyes off the road. Suggestions that visual tuning devices be applied to auto-radio sets have met with objection by some automotive engineers who feel that the driver should not be encouraged to turn his eyes to the tuning device while driving.

AFC will aid drivers

When the new "automatic frequency control" feature is applied to auto sets, the driver in future will be able to turn the dial merely *near* the station wanted and yet will tune in the signal sharply and clearly. Even detuning ten kilocycles or more, the set still remains sharply tuned in on the station. In this way the AFC feature will be a great convenience to the car driver and an aid to safe driving. Such automatic frequency control tuning is expected to be available on auto radios within the year.

Tuning range of automobile sets is still a question that bothers the receiver manufacturers, since there are laws against carrying on a private car radio apparatus capable of receiving police radio messages. While legislation of this type was introduced by well-meaning persons who felt it would be an aid in keeping police warnings out of the hands of criminals, the actual result has been to keep valuable short-wave programs away from law-abiding car-owners, while the criminal

groups have, of course, no trouble in adapting sets to intercept police broadcasts at will.

Present standard range of tuning for auto radio sets is 540 to 1500 kc., while standard home broadcast receivers must, by RMA specifications, reach to 1600 kc. to take in the new high-fidelity band. Until an expected conference can be held between police officials and representatives of the Federal Communications Commission, auto-radio design engineers prefer to keep shy of the 1500-1600-kc. band, fearing accidental overlap with police.

In an effort to reduce lead-in losses, thereby conserving the small signal voltages, shielded transmission lines from the antenna to the set have been developed. The operation is similar to that of the all-wave antenna with its matching transformers and twisted-pair lead-in.

In one system, which is standard equipment with the Arvin auto sets, a coupler is mounted in the top of the car where the lead is attached to the antenna. This coupler also contains a filter tuned so as to reject motor noise. A shielded two-wire matched-impedance line runs from the roof coupler to the antenna transformer on the set. Manufacturer states that noise is greatly reduced since practically all of the signal picked up by the antenna is delivered to the set—and the lead itself does not pick up any noise.

General Electric's new set employs six metal tubes in a superhet circuit. An iron-core antenna transformer with tapped transformer allows for the use of high and low capacity antennas. Set has numerous other features such as custom type controls, tone control, non-polarized power supply, and compact construction.

Five compact models with a choice of metal or glass tubes are featured in Atwater Kent's 1936 line. Both all-in-one and dual unit models are available. There are controls to match 33 models of the leading car manufacturers.

Emerson's new set employing glass tubes features an audio automatic volume control that provides remarkably uniform output level.

Fada's new Motosets feature metal tubes in a 6-tube circuit. High-gain with all antennas is assured by iron-core input transformer. Matched-panel equipment is available for all cars and header speakers for Ford and General Motors cars. Single and dual unit types are featured.

A feature of all standard radios which the radio dealer can employ to his advantage, is that of the adaptability of the sets he sells. Controls can be obtained for all popular cars so that the set can be removed from the old car and installed in the new one. Many of the sets sold through automotive dealers are designed for a particular make of car, and when the owner turns that car in for a new one, he cannot always get controls that will fit both the new car and his old radio. This is the basis of a good argument for buying an auto radio through a radio dealer, who, at the same time understands installation and radios much better than an automotive dealer.



There's a "Century of Progress" note in these shops of the Simon Distributing Co., Crosley and Motorola jobbers, Washington, D. C. Company makes a strong bid for auto drive-in installation and service.

THRU THE LABORATORY KEYHOLE

METAL VS. GLASS TUBES IN NEW SETS.

★ New 1936 models coming through the design departments in certain quarters show something of an increase toward metal tubes in the lower-priced sets. The increase in metal-tube models is "slight," in the words of one engineer who has checked with a number of set-manufacturers' designers, but it is nevertheless definite, based on economic grounds.

Price has heretofore been an important hurdle in the metal-tube situation, and as the differential between the cost of glass and metal tubes narrows, the tendency is to take advantage of the sales arguments that have been presented for the metal tube.

Last year metal-tube prices averaged about twice glass-tube prices.

This year metal tubes for "initial equipment" cost only 25 per cent to 30 per cent more than glass, so that the metal unit more readily competes with the glass tube when it comes to providing set manufacturer's initial tube equipment. This means that metal tubes may invade lower and lower price brackets of radio sets, giving battle to the glass units on ground that has heretofore been regarded as exclusively glass-tube territory.

Auto radios comprise another new field for metal-tube development in 1936.

Meanwhile several of the set manufacturers who have faithfully held to glass, while continuing an all-glass policy, are reported to plan to switch to octal-base receptacles, so that they will be in position to swing to metal if price and technical conditions warrant it.

RADIO "FLATS"

★ Compact receiver-cassis layouts made possible by metal tubes and new space-saving speakers, have suggested that the radio set of the future may be a flat affair, not over 2 or 3 inches thick.

Already work along these lines is going on in several laboratories. Such a flat set would preserve the large front area needed for baffle purposes, thus retaining good tone quality in the lower registers.

But the whole receiver would be little thicker than a framed picture on the wall — and might be hung in the same way, as a decorative element on the wall of the room.

Elephant stepped on it

As the decorator people get hold of the possibilities behind such an idea of "radio flats," a distinct new mode in radio receivers is likely to result. Panel-like cabinets will be grateful relief from present bulky boxes, which have been the despair of some artistic souls.

So perhaps instead of table models, we shall have "wall models," and the squat midgets and jalopies of the 1933-35 era will become as passé as Model T Fords.

In a stream-lined world of simple and severe interiors, radio sets may have to go ultra-moderne and "as flat as a pancake." "Flounder" models may be all the rage year after next, and the popular advertising appeal may be: "Flat as if the elephant stepped on it."

Whew!

TELEVISION BY CABLE

★ During the same week that the Federal Communications Commission granted authority to the American Telephone & Telegraph Company to lay 90 miles of co-axial cable between New York and Philadelphia, capable of carrying million-cycle television pictures in both directions, news came of television transmissions by wire between Leipzig and Berlin in Germany, cities 186 miles apart.

Germany's long-distance telephone-television circuit was set up in connection with the opening of the Leipzig Industrial Fair. For \$1.40, callers could converse for three minutes and meanwhile see each other's image 8 inches square.

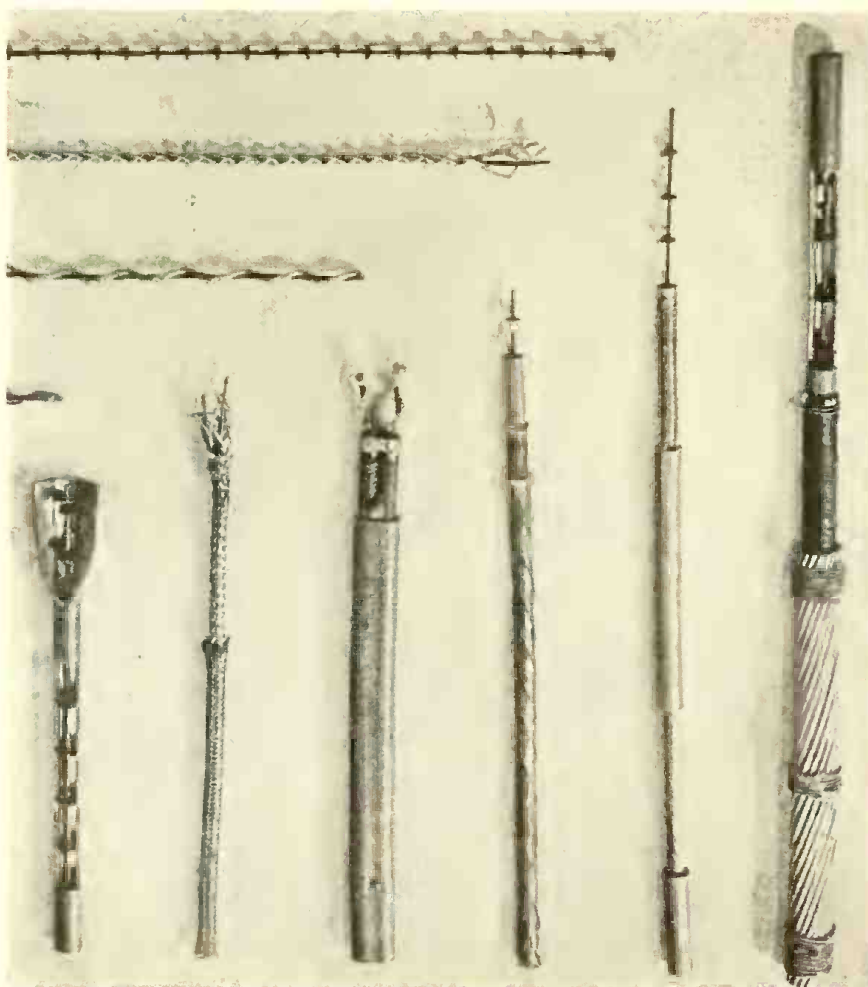

Co-axial cable in various forms, developed by Bell Laboratories for 90-mile "television" installation, New York to Philadelphia.

While the A T & T co-axial cable has been planned primarily for the transmission of some 200 simultaneous telephone conversations over a single conductor, the wide frequency band thus made available is suitable for television pictures. With the advent of such co-axial cables, television networks could be set up between principal cities, and television station interconnection would not be limited by short-waves to horizon distances as was first feared.

FACSIMILE BY FREQUENCY MODULATION

★ Tests of the new system of frequency modulation developed by Major Edwin H. Armstrong, inventor of the feedback and superheterodyne circuits, are now being carried on between New York City and Camden. In this new method Major Armstrong varies the frequency of the transmitting circuit, in contrast with the "amplitude modulation" system now generally used, in which the strength of the radio emission is varied by the modulating signal.

Employed on the ultra-high-frequency channels (41 to 110 megacycles), the new system has resulted in a tremendous decrease of interference from static, compared with simultaneous transmissions over the broadcast channels. This increase of signal strength as compared with static, has been as high as 50,000 times. While removal to the ultra short-wave channels probably accounts for a 100-to-1 reduction in static, the remaining improvement of 500 or 1000 to one results from the frequency-modulation principle alone. Unfortunately this frequency-modulation principle cannot be applied satisfactorily in the region of the longer wavelengths, but requires a wide band of unused adjoining frequencies over which the transmissions can be swung. It is therefore limited to the short-waves below 15 and 10 meters.

Simultaneous music

Frequency modulation has been employed successfully for the transmission of voice and music, facsimile impulses, and synchronizing signals. In the case of the accompanying facsimile reproduction of a front page of the New York Times, the facsimile was sent during a heavy thunderstorm simultaneously with a musical program and the control signals. Transmission of the page shown was from the 1250-ft. Empire State tower in New York City, and the combined signals were picked up, and separated out

by filters, in a basement laboratory near Camden, N. J., 85 miles from New York.

The musical program heard on the standard broadcast channel from a 50-kw. New York broadcast station was so shot with deafening static and lightning crashes, as to be impossible to listen to; meanwhile the same program on the ultra-short-wave channel, frequency-modulated, came through practically unmarred by static. The freedom of static on the facsimile signal is strikingly shown by the newspaper page herewith.

ACOUSTICAL LABYRINTH

★ U. S. Patent Number 2031500, covering nineteen claims on the "acoustical labyrinth" has just been awarded to Benjamin Olney, Stromberg-Carlson acoustical engineer. At present the acoustical labyrinth is used on four of Stromberg's high-fidelity radios.

The long, winding passageway of the labyrinth, lined with a special acoustical material, takes the place of the usual box-like cavity in the cabi-

net, which is the source of the exaggerated boom in the low tones. The air column of the labyrinth is so tuned and proportioned that it not only removes this exaggeration, but also extends the range of bass notes that are effectively reproduced. At the same time, the volume-handling capacity and accuracy of performance of the loud speaker are increased by the provision of an adequate air load.

Says Mr. Olney: "Recent laboratory tests show that the new labyrinth alters our conception of necessary baffle size. Up until the present time, everyone has considered a large console necessary for good bass reproduction—in fact the larger the better. We now find that the acoustical labyrinth in a cabinet only twenty-six inches square, which may be, and preferably should be, placed against the wall, is just as good for baffle as a tremendously large console, or even the side wall of a room.

"This being the case, the radio cabinet need now be only of sufficient size to house all the apparatus, and can be much more attractively and appropriately designed."

New York Times

Copyright, 1936, by The New York Times Company.

NEW YORK, TUESDAY, JULY 23, 1935. P TWO

<p>ers Test o Society, ing u have re- asured as vere issued, give school is to sup- ring new- an any they ut there it part of the the "loyal- direction e teachers' ties, to re- follow: blunt mes- sages. good man cooperation. street Eng- ing, teach- reliability. cheerful- apathy for d in adap- tion of col-</p>	<p>TERRE HAUTE PUT UNDER TROOP RULE IN GENERAL STRIKE</p>	<p>RELIEF ROLL PURGE PLANNED TO MEET NEED FOR WORKERS</p>	<p>BRITISH ENVOY BUT SEEN PROPOSAL</p>
	<p>2,000 Guardsmen Move Into City as Governor McNutt Orders Martial Law.</p>	<p>Abrogation of Existing Lists and Stricter Regulations for Re-admission Planned.</p>	<p>Present Naval Riots For Two Years,</p>
	<p>TIE-UP HELD '90 PER CENT</p>	<p>FEDERAL LISTS CLASSIFIED</p>	<p>Treaty in Effect Until End of 1935 Parley This Year—British Po German Race—Roosevelt S</p>
	<p>Union Men Quit in Sympathy With Enamel Plant Strikers—Food Shortage Feared.</p>	<p>Re-employment Service Will Aid Efforts to Fill Industrial and Farm Jobs.</p>	<p>WASHINGTON, July 22.—Abandonment by Great Britain of the naval ratios written into the Washington treaty of 1922 and tentatively in the London treaty of 1930 occasioned disappointment here today but apparently no surprise. Officials declined to comment on the announcements made before the House of Commons by Sir Bolton Eyre-Mansell, First Lord of the Admiralty, but there was an evident belief in informed quarters</p>

Newspaper page transmitted 85 miles from Empire State tower, New York, to Camden laboratory, simultaneously with musical program, on 41-megacycle channel by Armstrong frequency-modulation system.

TODAY'S BIG PROGRAMS TO SELL SETS

Features are listed for demonstration during business hours.

★ DEAD certain that prospects "think programs" when they think of buying new and better radio sets. Dealers are slyly eyeing the program lists for significant features with which to dramatize the reception qualities of 1936 models.

On this page RADIO TODAY presents its much-demanded and much-checked list of appropriate programs for showing off good receivers during store hours. Selections were made from national network billings, on a basis of tonal effects needed to accent fidelity in reception. Educational, informative, and other important aspects of programs were not considered in this case. All times are Eastern Standard.

MONDAY

- 9:15—Streamliners—NBC—Red. Good voices singing the old stand-bys from earlier musical comedy.
- 10:15—Edward MacHugh—NBC—Blue. Singer with a rich, deep voice.
- 10:30—Poetic Strings—CBS. Popular arrangements of familiar classics.
- 11:00—Harmonies in Contrast—CBS. Comparative studies in music, inviting concentration in listening.
- 11:00—NBC Light Opera Co.—NBC—Red. Your best light opera before noon.
- 12:15—Musical Reveries—CBS. Interesting variety in singing and speaking voices.
- 2:00—Between the Bookends—CBS. An unusual voice here.
- 2:30—Melodies—NBC—Red. A Russian contralto singing gypsy songs.
- 4:00—Concert Miniatures—CBS. Leisurely salon and light classical music.
- 4:45—Grandpa Burton—NBC—Red. A sketch which invites close listening.

TUESDAY

- 9:45—Fred Feibel at the Organ—CBS. Powerful, room-filling music.
- 10:15—Romany Trail—CBS. Lively Hungarian folk music.
- 10:45—Three Shades of Blue—NBC—Red. Male trio with successful harmony effects.
- 11:00—Shut-in Hour—NBC—Blue. U. S. Marine Band.
- 1:45—NBC Music Guild—NBC—Red. Lesser-known compositions from great composers.
- 2:00—Between the Bookends—CBS.
- 2:30—Rhythm Octet—NBC—Red. Includes a good sample of how a piano duo should sound on the air.

- 3:30—Library of Congress Chamber Music Series—CBS. Impressive music to any listener.
- 4:00—Woman's Radio Review—NBC—Red. Another example of pleasant voices and good music on the same program.
- 4:30—Vivian Della Chiesa—CBS. Excellent soprano voice and concert orchestra.
- 5:00—Meetin' House—NBC—Blue. Negro voices affording a study of harmonic effects.

WEDNESDAY

- 10:15—Edward MacHugh—NBC—Blue.
- 10:30—Along the Volga—CBS. Lively Russian Folk music.
- 11:00—Maurice Brown—CBS. Good performance with the cello.
- 11:30—U. S. Army Band—NBC—Blue. This is OK for trying out volume.
- 12:00—Gould and Shefter—NBC—Red. Same piano team as in Tuesday's Rhythm Octet.
- 12:15—Musical Reveries—CBS.
- 12:45—Jules Lande and his Concert Ensemble—NBC—Red. Interesting to show harmonic effects with the strings, reeds, and wood-winds.
- 1:45—Dorsey and Dailey—CBS. A duo which gets vocal effects not available elsewhere.
- 2:00—NBC Music Guild—NBC—Red.
- 2:45—Don Pedro and his Orchestra—NBC—Red. Includes an electric guitarist.
- 3:00—Rochester Civic Orchestra—NBC—Blue. Approved for symphonic demonstrations.
- 4:00—Curtis Institute of Music—CBS. Heavy orchestral effects and guest soloists.
- 4:30—U. S. Navy Band Symphony Orchestra—NBC—Blue.
- 5:00—NBC Concert Hour—NBC—Red. Expertly directed orchestra.

THURSDAY

- 10:15—Music in the Air—CBS. Ideal program of string music and vocalists.
- 11:00—Ida Bailey Allen—NBC—Red. Excellent feminine voice and good tenor.
- 11:30—Fountain of Song—NBC—Red. Furnishes examples of baritone voice, harmonizers, and two-piano effects.
- 12:15—Johnstone Ensemble—NBC—Blue. Tenor, soprano voices and a piano team.
- 1:00—The Three Keys—CBS. Three girls doing good work with popular songs.
- 1:30—Glass and Krauter—NBC—Blue. Affords tone studies in piano-cello duets.
- 2:00—Matinee Musicale—NBC—Red. Soprano and tenor

voices, heard with a good orchestra.

- 2:30—NBC Music Guild—NBC—Blue.
- 3:15—Eastman School Symphony Orchestra—NBC—Blue. Students from string and woodwind ensemble classes.
- 3:30—Do You Remember?—CBS. Pleasant presentation of old favorite melodies.
- 4:15—Howells and Wright—CBS. One of the best piano duos.
- 4:30—Radio Guild—NBC—Blue. Important for dramatic voices.

FRIDAY

- 9:30—Beatrice Fairfax—CBS. Specially interesting to women.
- 10:15—The Captivators—CBS. Good for orchestral variety.
- 12:15—Musical Reveries—CBS.
- 12:45—Jules Lande and his Concert Ensemble—NBC—Red.
- 1:00—The Instrumentalists—CBS. Good for illustration of unusual arrangements.
- 1:15—Concert Miniatures—NBC—Red.
- 1:45—Mount and Gest—CBS. Another first-string piano duo.
- 2:00—The Magic of Speech—NBC—Red. Accenting the fine points of speech.
- 2:45—Don Pedro and his Orchestra—NBC—Red.
- 3:00—Bolek Musicale—CBS. Intriguing vocal and instrumental selections.
- 3:45—Mark Warnow's Blue Velvet Orchestra—CBS. This is as smooth as it sounds.
- 4:15—U. S. Army Band—CBS.
- 4:45—Strolling Songsters—NBC—Blue. Fine combination of songs and an interesting speaker.
- 5:00—Airbreaks—NBC—Blue. Lively variety.

SATURDAY

- 10:15—Edward MacHugh—NBC—Blue.
- 11:00—New York Philharmonic Children's Concert—CBS. Stirring concerts of universal interest.
- 11:15—The Norsemen—NBC—Red. Quartet of well-blended male voices.
- 11:30—Whitney Ensemble—NBC—Blue. Tone-testing performance with two violins, viola, cello and piano.
- 12:15—Musical Reveries—CBS.
- 1:55—Metropolitan Opera Matinees. (Time varies according to opera house schedule)—NBC—both nets.
- 2:45—Concert Miniatures—CBS.
- 3:30—Tours in Tone—CBS. Instrumental bill of variety and charm.
- 5:00—Musical Adventures—NBC—Blue. Includes impressive concert piano numbers.

STARS THAT SHINE IN THE DAYTIME



MORNING AND AFTERNOON, the radio dial always has a star. Above (left) is Elizabeth Day, CBS actress. Left (center) is NBC's Walter Damrosch; left (below) Vivian Chiesa, CBS singer.

Above (right) is Erika Zaranov, Russian contralto who stars for NBC, and below is a song and comedy group from the same studios known to listeners as the Landt Trio and White.

THE RADIO "DEALER'S DIGEST"

Pointed stories of sales drives tried out by scattered dealers

TWO-IN-ONE SALESMEN

★ Just using a list of serviced customers as a general prospect list is not sufficient for Brody's Music Shop, Inc., Jamaica, Long Island, N. Y. H. Bulkin, Brody's manager, likes to use men who are able both to service sets and to sell them. These double-purpose gents use service calls as an entree and tactfully branch into an outline of reasons why the patron should invest in additional sets. It has to be done neatly, else the sales talk will appear to be out of place.

As for Brody's shop itself, you can't get in the place without bumping into a console. It is placed nearly half way across the entrance, and of course it is tuned in one some impressive broadcast.

NIGHT DRIVE FOR SALES

★ An all-night sales drive that resulted in 32 orders for radios and \$500 in cash collected has been made by the Midland Radio Company, Indianapolis, Ind.

Not till the evening of the event were the Midland men informed of the all-night drive. They went out into the industrial districts, sub-

urban farms and markets, and contacted over 100 prospects with no leads of any sort. The 36 men made 26 radio sales by midnight, and 32 by six the next morning.

Only lead of any sort given to the salesmen was to go wherever they saw a light and interview whoever was there. They went to police stations, dairies, bakeries, farms, markets, factories, warehouses, railroad roundhouses, and the like.

To all prospects a direct-mail follow-up was immediately dispatched—a personalized letter in the salesman's own handwriting, conveying the salesmen's thanks for the time given him.

PROSPECTS GO ON THE AIR

★ Operating a short wave station in connection with his regular radio business has been a good publicity stunt, according to George F. Klein, of Klein's, Inc., Miami, Fla. People like to come in and see it in operation, and get a great thrill in their ability to go on the air and carry on a personal conversation with other radio operators who are reached by the short wave apparatus.

Station W4CNA operating on the

160-meter amateur radio phone band is located in the rear of Klein's shop. It gained recognition during the last hurricane which visited Miami and when every other means of communication with the outside world had failed.

Another business producing plan followed by Klein's is this: When a service call comes in over phone, a new machine is sent out when the car goes to pick up the old instrument, so that the customer will not be inconvenienced by being without a radio while his is undergoing repairs. Several days afterward Mr. Klein calls at the home ready to give an estimate on the repairs necessary for the old radio. He endeavors at this time to sell the new machine and in a surprisingly large percentage of instances is able to do so.

COOPERATION 100%

★ Dealers of the San Joaquin Valley, California, of which the town of Fresno is the center, have been cooperating on a scheme to improve their sales simultaneously. Tabulated monthly sales figures are sent by each dealer in the area to a neutral agency—the San Joaquin Light and Power Co.—and the combined results are distributed in bulletin form. No dealer's individual record gets into the hands of a competitor.

This cooperative device gives all dealers a chance to compare their own sales curves with the average one, and to determine which items are the largest sellers in the territory.

RAPID REPLACEMENT

★ Way to crash the radio replacement market is to make owners dissatisfied with their old sets and want the new ones, insists W. L. McAllister, manager of the radio and refrigeration department of Loveman, Joseph & Loeb, Birmingham, Ala. This means demonstration of the new models in the homes, he believes.

Accordingly he has assigned three radios to each salesman, who works a specified territory, keeping the sets out on demonstration all the time if possible. The demonstrators are moved from one home to another,

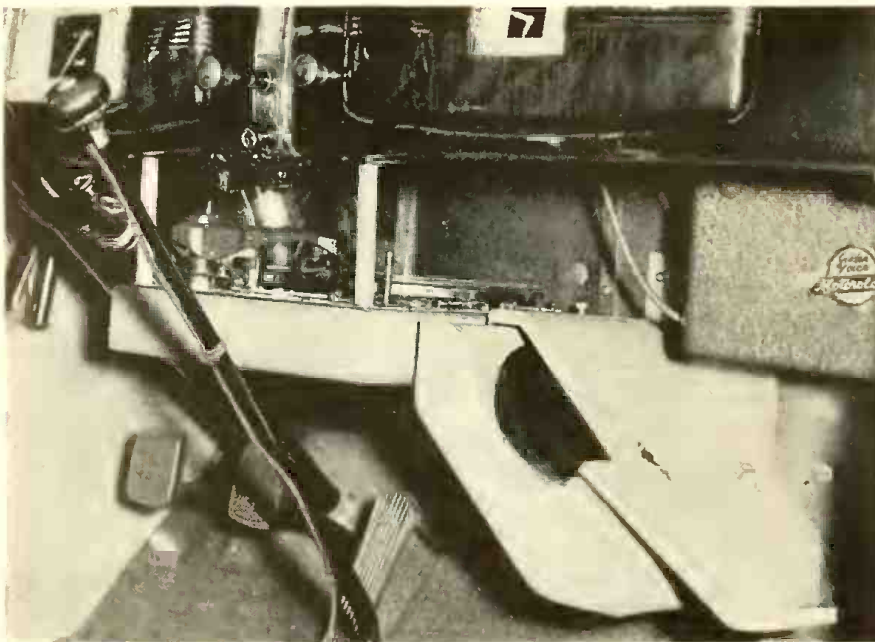

Installation of an automatic record changer and player in new Buick 8 is latest feat of MacAdams Equipment Co., New York. Six-volt mechanism fits under dash panel along with 10-tube radio and speaker.

keeping them out in the same neighborhood so far as feasible.

The prospect is required to sign nothing for a demonstration, but only to signify his interest in the new model, whereupon he is allowed to try it out for three to five days. After that time the salesman calls on him and endeavors to make a sale, taking the old set in trade, allowing not more than 10 per cent of the price of the new set.

"The automobile salesman's technique is to get the prospect behind the wheel, and in our business the job is to get the prospect's hand on the dial. The new model in comparison with the old will then almost sell itself," comments McAllister.

DE LUXE CAMPAIGN

★ Mr. (Personal Contact) Silver of the Silver Auto and Radio Supply Co., Champa, Denver, Colo., believes in keeping plenty of sales irons in the local fire. Every day for months after the introduction of new models, 5 men are kept ringing door bells throughout the city; each is required to enter 70 homes a day, and each carries a testing kit.

Silver's have a telephone girl who makes 300,000 calls a year on the subject of radio service. Company also buys time on the air, and uses thousands of handbills. Otherwise, the store makes a practice of keeping a set playing at every entrance to the store, and has an expert serviceman remain on duty on Sundays to handle emergency repair calls.

CALIFORNIA "SELLER-UP"

★ Don Webb, of the Glendale (Calif.) Hardware Co., trades up almost 100 per cent on radios. Starting as low as \$12.50, he has been able, time after time, to end up with a \$75 or \$100 sale. Sometimes this is accomplished before the first set leaves the store; again, it takes a year, or even two years.

"The first thing necessary," explains Mr. Webb, "is not to be too eager to take the shopper's twelve dollars and close the deal then and there. It is a great temptation not to sell the cheaper set; we have no resistance, the customer is already primed, we may feel that there is a danger of losing the sale if we let it hang fire. Then we say to ourselves: 'You are doing the customer a favor by selling the better set. A radio is something the user lives with constantly.' That puts us in the right frame of mind."

Second step is to present the sets in a manner that will make trading

up easier. The physical arrangement of the corner of the store devoted to radios is an important aid. In one corner is the tube testing device and the tube stock. This is flat against the wall. In order to reach this corner it is necessary to pass around the radio display.

The cheaper set is *always* demonstrated. This is the best way to convince the customer that he should have the better set; his ears know. While demonstrating, the clerk turns on the next set in the line, casually inviting the customer to listen to this one. The result is not always an immediate response. In that case, the clerk can jump to a still more expensive one, where the difference in tone is readily apparent, even to a dull ear. The customer cannot be expected to sell himself, wholly. But this is an accurate comparative basis for ordinary salesmanship.

DEVICE SELLS CONSOLES

★ Easy and effective method for "selling up" to higher priced sets has been discovered by Fred O. Schwender, radio dealer of Utica, N. Y. Device is based upon the conclusion that a console model has a better tone quality because it has more baffle; many table models produce flat and unconvincing programs because of limited facilities in that respect.

Schwender declares: "Loosen the speaker in any of your consoles and take it away from the cabinet—your tone goes absolutely flat." This demonstrates the difference.

REPLACEMENT STROKE

★ At the John A. Schwartz Stores, Inc., Jamaica, Long Island, N. Y., there's a suggestion in use on the sales floors which is genuinely a smart one.

When a customer comes in and says that he wants a small set for a specific room, to supplement a console he already has, this store is alert enough to suggest that the old console be moved to the basement and a new one installed upstairs. Arthur Hettick, manager, has the dope on how people are arranging their basements into very attractive dens, game rooms, etc., and often interests the customer in the idea, even when it's completely new. Like this, he manages to sell a console instead of a small set. Idea has further applications, of course.

EXCHANGE OF TIPS

★ By sticking exclusively to home radio repair service and auto set installation, the Linden Radio Service, Baltimore, built up a large radio service business. This organization is engaged in doing all the repair and installation work of several retail stores, and for that reason does not enter the selling domain, which belongs strictly to the selling organizations.

However, whenever it is seen that the set to be repaired is obsolete and that it would be economy to replace it with a new set, the Linden concern turns such prospects over to the retail stores from which it gets its service work.



In a political year, business offices turn out to be important sales prospects for radio dealers. Picture shows GE table model on desk of busy exec.

STUDY CUSTOMER WANTS

- know what is selling, what is asked for
- maintain balanced assortment of models
- remember — “The customer must be satisfied”

By H. L. M. CAPRON

★ A COMPLETE assortment of “wanted” merchandise is a prerequisite to the production of an ever-increasing sales volume, for people must be capable of buying *what they want* when they come to your store in response to your advertising and promotional efforts.

A balanced assortment can only be maintained by *knowing* what is selling and what is *asked for*. To replace fancy with fact, it then becomes absolutely necessary that an accurate record of sales by units be kept, and that “calls” be recorded and tabulated as carefully as actual sales.

On the basis of “calls,” models that people are asking for that you do not carry—new merchandise should be added to your assortment.

On the basis of actual sales, you can buy with confidence those models which are selling, and intelligently reduce the prices of those which do not sell.

When glib salesmen try to induce you to buy models of which *they* have a surplus, at a longer discount, remember that you can make *no profit*, regardless of the discount, *until you sell it*. If it is important for you to clean your own stock of slow-moving models, it certainly is important not

to buy slow-moving models. With accurate sales records you may *know* whether the bargains offered you at this time of the year are genuine or not and take full advantage of those which are.

Plan to maintain a balanced assortment of wanted models, based upon the facts of your own business and community.

Merchandising is the art of buying and selling wanted products at a profit and *in a manner calculated to increase goodwill and reputation*.

Goodwill and reputation are the products of *time and satisfaction*.

Balanced stock

Watch the trend in changing consumer preferences as to style trends, price groups, buying habits, and act on them.

Since the novelty appeal has long since passed, and the original radio market has definitely been displaced by the replacement market, customer satisfaction, and the Service Department, are going to be much more vital in the future than they have been in the past.

Plan to satisfy every customer, cost what it may.

Your Service Department should

be manned by a thoroughly capable crew of men, who thoroughly understand the complex modern all-wave and hi-fidelity receivers.

They should be equipped with modern instruments, including the oscillograph, and be able to get out of a radio all of the performance that the designer and manufacturer built into it.

Customer satisfaction

With a Service Department so manned and so equipped, the ultimate value will be determined by the policy under which they operate.

A *policy* may seem like an intangible expression, but it can, and should, be made a living vital thing to your business as your heart is to your body.

The foundation of your policy may well rest on the simple statement, “*The customer must be satisfied.*” But you must *mean* it and practice it constantly.

A bond, or an insurance policy written by a well-known company, has been used very successfully by even large companies, to guarantee the performance of their products, or rather, to lend weight to their own guarantee, in the minds of those who do not know the reputation of the guarantor.

And remember that you will never see a “gyp” artist who will back his promise with more than his worthless word. The public knows that, too.

You have to believe it, too

But just putting a policy in words, like a slogan, means nothing.

You must believe in it sincerely, practice it enthusiastically, and be certain that every employee is as thoroughly indoctrinated and as enthusiastic as you can make him.

Put that life, and being, into your policy, and your customers must know it, too, and have confidence in you.

Plan carefully and base your plans on the facts of your own business.

Plan to so run your business that the facts will be constantly and readily available to you, and then use them.

Plan to merchandise your business.

Plan to maintain a full assortment of wanted models.

Plan to maintain your stocks in proper relation to sales.

Plan to advertise consistently.

Promote your business as energetically and as enthusiastically as you can.



Ten years of “satisfied customer” service in a responsive community — the REB Service Corp., Flushing, New York, celebrates with a brightly revamped shop.

Only the new 1936

ATWATER KENT

Auto Radio

OFFERS ALL THESE
EXTRA-VALUE SELLING
FEATURES!

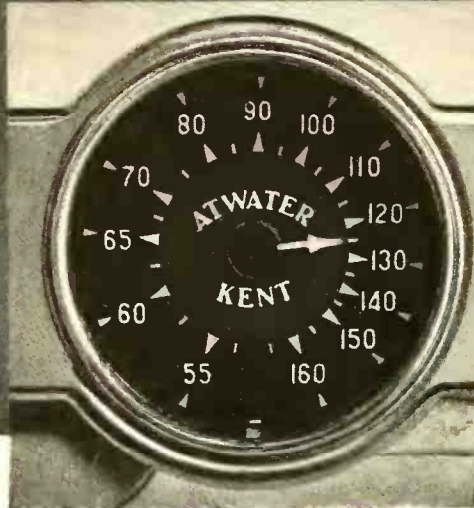

ARROW-LIGHT TUNING: The latest Atwater Kent feature mounted right on the instrument panel. Easy to read. Just follow the arrow to *perfect* tuning.

RUGGED CONSTRUCTION. The rugged chassis construction assures dependable performance under all conditions.

MARVELOUS HOME RECEPTION FROM OVERSIZED DYNAMIC SPEAKERS. The clear rich sound of music or voice from the oversized speakers makes listening identical with home sets.

TAILOR-MADE FOR YOUR CUSTOMERS' CARS. Distinctive remote control plates styled to match instrument panels of thirty-three car models.

BUILT-IN ANTENNA BALANCER. This balancer matches the antenna on the car to produce highest efficiency in sensitivity and volume.

ARMOR-SHIELDED POWER UNIT. Rugged, compact unit totally shielded—new improved vibrator, tube and power transformer.

NO SPARK PLUG SUPPRESSORS. Specially designed circuits with built-in filters eliminate the necessity of spark plug suppressors.

MOTORING SEASON IS HERE! Baseball games are on the air... pre-election speeches... dance bands for the young folks. Never before was there a riper moment for the appearance of the new 1936 Atwater Kent Auto Radio... "today's greatest auto radio value." This is the set your customers have waited for: the greatest Auto Radio ever to bear the name Atwater Kent.

\$39⁹⁰
and up
f.o.b.
factory

ATWATER KENT MANUFACTURING COMPANY
A. Atwater Kent, Pres. • Philadelphia, Pa.

LATEST ATWATER KENT FEATURE ARROW-LIGHT TUNING

The lighted arrow marks the station with a new tuning efficiency that assures speedier selection of programs with the finest Atwater Kent tone quality.



FAMOUS ATWATER KENT PRECISION ENGINEERING

Again Atwater Kent precision engineering does its part in making the 1936 Atwater Kent Auto Radio "today's greatest radio value"... in name and in fact.

April, 1936

An Unusual Opportunity

FOR RADIO DEALERS...

During the last Christmas selling season, the farmers of the country purchased a record-breaking number of battery-operated radio sets.

To hold the initial cost of these sets as low as possible, a fair percentage were undoubtedly equipped with short-lived dry cell "A" packs and cheap "B" batteries.

These batteries are now due to be giving out. This presents you with a fine opportunity to equip these sets with the most satisfactory type of "A" power—the "Eveready" "Air Cell" "A" Battery, and the longest lasting "B" Battery made—the "Eveready" "Layerbilt."

Go after this replacement business. Each "Eveready" "Air Cell" and "Layerbilt" installation means another *satisfied* customer and more money for you.

We are going to help you with large-size, hard-selling advertising in a big list of farm magazines—with a *monthly* circulation of nearly 9,000,000 farmers!

The "Eveready" "Air Cell" "A" Battery



Installed now, it will give service 3 hours a day—every day,—until *after* election!

The "Eveready" "Layerbilt" "B" Battery



The world's finest "B" Battery. Specially suited for use with "Air Cell" receivers.

EVEREADY BATTERIES

LAST LONGER . . . MORE DEPENDABLE

The words "Eveready," "Air Cell" and "Layerbilt" are trade marks of National Carbon Company, Inc.

FARMERS SIGN THE DOTTED

- gentlemen of soil continue to insist on politics
- general farm conditions point way to more radio sales
- figures on farm incomes show vigorous pick-up

★ THIS is not the story of the farmer's daughter, but rather a check-up on the whole family.

It is impossible to keep farm families out of front page radio news during a presidential year; a farmer's interest in politics is both instant and intense. He has a traditional concern with Washington's affairs and can be depended upon to linger about his radio if anything political seems likely to happen.

Agricultural folk have found themselves interested in politics earlier this year and have been all ears ever since the Supreme Court ditched their god-administration, the AAA. That element has pre-stirred the farmer's natural passion for politics.

To the front

Makers of battery sets of the 1936 style have furnished the farmer his final ticket to the political uproar. He has been offered, through the new sets, his greatest chance to be in on everything that takes place in the action centers of the 1936 election machinery.

Luckily, at this point he has ready money to spend, compared to his status of other years. Gross income for 1936 of U. S. farmers is estimated at over 9 billion, while the figure for last year was about \$3,110,000,000. Of the 9 billion, some \$3,000,000,000 is definitely designated by the experts as "money to spend." Latter figure is about \$300,000,000 over the similar total for last year.

Better days

Latest reports from the Bureau of Agricultural Economics of the U. S. Dept. of Agriculture contain such sentences as these:

"The entire North has been blanketed with a fairly heavy cover of snow which . . . has benefited winter grains and meadows."

"The general story within the livestock industries is one of increasing production."

"In the West there are said to be about 78 per cent more cattle on feed than last year, which is about 1/3 more than average."

"The economic position of Corn

Belt farmers was considerably improved at the beginning of 1936 as compared with recent years."

"The wheat situation at the beginning of this year was materially stronger than a year earlier."

On top of all this, the farmer's Conservation Act has been passed by Congress and signed by the President. It provides for farm payments amounting to \$500,000,000.

Actual farm profit

From Washington come the figures on the last four years of agricultural activity, in point of the ratio of prices received to prices paid by the farmers of the nation. In 1932 that ratio was 61; the next year it leapt to 64, and in 1934 it had rushed up to 73. For the year 1935 that ratio was 86.

For 1936 these ratios are available so far only on the month of January, but the beginning has a healthy look. The figure was 89; three points above the 12-month average for last year.

Radio means money to farmer

Even if the farmer were cool to politics, there are dozens of other reasons for his going to the radio store, now that he has the money to invest.

Incident after incident has been reported where farm radio owners have saved the whole price of the set, by some chance report on market prices which prevented selling out at figures below the market, upon the first offer of some wily stranger.

Weather reports over the radio have enabled farmers to save their fields of alfalfa, when storms were impending. Cotton and other crops have been marketed advantageously, when the producer knew where and when the best opportunities for good prices were to be found.

Half of the rural population, counting both farms and villages, does not read a daily newspaper. The country "weekly" serves their reading needs. And so into the gap steps radio, providing flash news service ahead even of the metropolitan dailies, bringing inspiration and education to the isolated acres, and enlivening the home with music for every taste.

Must be good set, installed right

In the old days, farm women frequently went insane from the loneliness of their lives; farm boys and girls escaped to the city at the first opportunity. But with radio all this is changed. And the farm home becomes the best possible place to live.

Experience of radio dealers who take their farm sales earnestly, shows that rarely does a radio come out, after it is once installed in a farm home. Give the farmer and his family 24 hours or more to twirl the dials, and the sale is made. The radio dealer can collect his money.

Broadcasters have remembered the farmer's tastes and his needs, with excellent results.

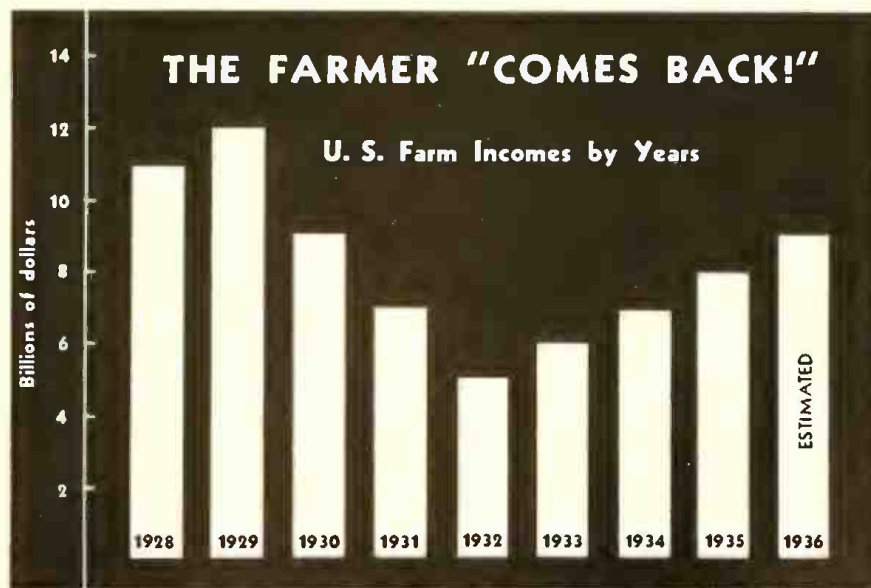

FARM RADIO PROSPECTS—WHERE AND WHY

★ Current emphasis on farm radio has prompted various manufacturers to dig up new figures on market possibilities among the homes in the dell.

Figures in accompanying chart show the number of farms in each state having a yearly income of "\$1,500 or more," number and percentage of such \$1,500 farm yet un-

wired, as well as the total number of unwired farms in each state.

Columns below on total unwired farms and average wind velocities compiled by Wincharger Corporation, Sioux City, Iowa. Others from RCA.

Note that figures on numbers of farms in each state are given in nearest thousands. Thus "Alabama, 24," indicates "Alabama 24,000 farms."

STATE	"\$1500 income" farms (Figures in nearest thousands)	Total unwired farms	Unwired "\$1500" farms	% of "unwired" "\$1500" farms Per cent	Average wind velocity range Miles per hour
Alabama	24	245	12	.80	5.6 to 6.9
Arizona	5	8	1	.06	4.6 to 7.5
Arkansas	31	237	28	1.92	5.7 to 7.6
California	75	48	—	—	4.7 to 9.5
Colorado	31	50	24	1.62	5.5 to 11.2
Connecticut	8	6	—	—	7.5
Delaware	5	7	4	.22	10
Florida	12	51	7	.47	5 to 10.4
Georgia	37	245	31	2.12	5 to 10.1
Idaho	25	26	13	.83	5 to 8.8
Indiana	71	146	49	3.35	6.2 to 11
Illinois	115	171	88	6.02	8 to 13
Iowa	155	163	124	8.46	7.7 to 12.2
Kansas	90	142	77	5.27	8.7 to 12.8
Kentucky	35	233	27	1.86	8.3 to 11.3
Louisiana	20	156	17	1.15	6.6 to 6.8
Maine	15	23	2	.13	8.5 to 11.1
Massachusetts	12	9	—	—	7.5 to 10.5
Michigan	66	117	32	2.20	5.7 to 11.5
Minnesota	114	161	100	6.84	7 to 12.2
Mississippi	36	308	32	2.20	5.2 to 7.3
Missouri	78	230	62	4.22	5.7 to 10.7
Montana	25	43	23	1.56	7.5 to 9.2
Nebraska	91	107	81	5.51	8.2 to 12.2
Nevada	2	2	1	.04	6.8 to 9.2
New Hampshire	6	16	—	—	5.4
New Jersey	15	8	3	.16	10 to 12
New Mexico	10	29	8	.53	5.6 to 11
New York	86	92	34	2.33	7 to 11.5
North Carolina	50	264	39	2.71	6 to 14
Ohio	90	153	44	3.01	10.4 to 12
Oklahoma	63	194	58	4.97	5.7 to 12
Oregon	24	34	7	.50	3.2 to 6
Pennsylvania	72	116	31	2.10	7.1 to 11
Rhode Island	2	1	—	—	10.6
South Carolina	20	151	16	1.11	5.1 to 10
South Dakota	57	74	54	3.80	8.2 to 11.4
Tennessee	31	233	23	1.55	6 to 7
Texas	131	472	119	8.16	6 to 13
Utah	13	10	—	—	7.8 to 10.5
Vermont	13	4	5	.34	11.2
Virginia	32	151	20	1.36	4.8 to 7.6
Washington	33	26	—	—	4.3 to 7.4
West Virginia	11	76	7	.47	4.2 to 5.7
Wisconsin	115	127	77	5.24	10 to 11
Wyoming	9	15	8	.55	4.4 to 7.5

DEALERS & BROADCASTERS, INC.

★ Natural and healthy hook-up between those who sell sets, and those who build the programs to be heard through them, got another successful demonstration recently in Grand Rapids, Mich. Stanley Barnett, manager of the local station, WOOD-WASH, operated by the Kunsky-Trendle Broadcasting Corp., addressed radio dealers and servicemen thus: "The sale, and the hours of daily use, of receiving sets in various cities have been found to increase in direct proportion to the signal strength and the dependability with which the public are able to hear the fine national programs . . ."

WOOD's letter was accompanied by a reprint of an ad from RADIO TODAY, recently run by NBC to dramatize the broadcaster-dealer interde-

pendence. WOOD thus began a plan of direct cooperation with local dealers; station managers had already held a meeting with Grand Rapids servicemen and bound them together with the program men in one powerful radio-promoting group. The station advises listeners to "see your authorized service man at least twice a year" and in turn the servicemen test and demonstrate at WOOD and recommend its programs to patrons.

PROGRAM DRAG

★ Crossley, Inc., the busy, busy research organization which is forever asking large groups of U. S. radio listeners about their program views, has recently talked with 4,000 of them in 11 station cities and 31 remote towns. (Remote towns

are those 25 miles or more away from a basic network station).

Crossley's prying this time were made on the subject of Wednesday-night network features on the air from 8 to 10. Among other things, the conclusion was that there's always room for two strong bills on the air at the same time. And Mr. Crossley himself remarks further: "Use of sets in the remote towns rated about 12 per cent better than that in station cities."

GRAY HAIRS DEPARTMENT

Editor RADIO TODAY:

May I congratulate you again on your ability to maintain a pace you have set for yourself in RADIO TODAY.

Maintain your pace, hell! The paper gets better as it goes along.

One critical point occurred to me, however, in reading your March issue. In the article "Modernize Listeners' Sets" you make the point that "three out of every four sets" need to be modernized.

From the dealer's point of view this is, of course, excellent propaganda.

But I wonder if it makes good sense from the industry's point of view?

Some people don't need much of a springboard from which to plunge into apparently devastating criticism of radio as an advertising medium. And it will not take very much more material like this—from within the radio family—to help them 'show' advertisers that "Radio ownership figures don't mean much . . . See how many sets are out of order!"

You and I know there is a vast difference between "sets being out of order" and "sets which should be modernized."

We also know that millions of people are entirely satisfied with their present radio reception if only because they don't know how much better it might be. Or don't care. They should be told, of course, how much better reception can be.

But advertisers may very definitely be impressed the wrong way by the phrase "three out of four old radios."

If it were an accurate impression, I wouldn't mind so much. But we know from the two years of Dr. Starch's surveys that at least 90 per cent of all sets are kept in working order.

We could have guessed as much, even without Dr. Starch, from the total amount of money spent for tubes and repairs in 1935, as reported in RADIO TODAY.

I don't know quite what the answer to the situation is. All of us, naturally, want the dealers to get as much business as they can and to keep home sets in the best possible working condition.

But in discussing the matter, it seems to me it might be a judicious thing to keep in mind the possible impressions we may make outside the industry.

Cordially,

VICTOR M. RATNER,
Advertising and Sales Promotion,
Columbia Broadcasting System,
New York City.

WINCHARGER FARM PAPER ADVERTISING

PACKS A WALLOP

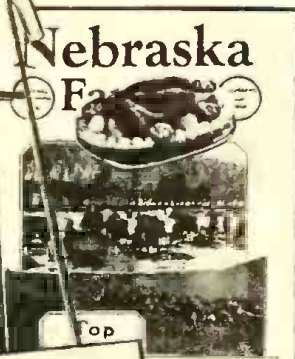

5,000,000 farmers are going to read attractive Wincharger display ads this year. Through these ads thousands will buy new six-volt farm radios.

If you want your share of this profitable 6-volt radio business, sell them the easy Wincharger Way. It's a leader—It's a closer.

New last year—internationally known and recognized this year.

WE SEND THEM IN — — — — YOU SELL THEM

WINCHARGER
CORP.
2700 Hawkeye Drive
SIOUX CITY, IOWA
U. S. A.



**5,000,000
UNWIRED FARM
HOMES
LET'S SELL THEM**

World's Largest Manufacturers of Wind Driven Battery Chargers.
Manufacturers of 32-volt Wincharger Since 1927.
Write for Complete Information on 32-volt Plants.



SELLING RECORDS

★ EXTRAORDINARY boost for records and recorded music is Leopold Stokowski's transcontinental tour during this month and next, with his Philadelphia Orchestra scheduled to play in 28 important cities of the country. Dealers along the way will regard the trek as a great cue for inspired promotion as the renowned musician exhibits his skill in personal appearances.

The Philadelphia group, sponsored by RCA Victor, can be regarded as one of the best possible organizations to stir local interest in instrumentation as its best. The concert series will be of sure-fire interest to students, music clubs, local orchestras, broadcasters, etc., and the advance dates give dealers a perfect chance for effective plugging along original lines. Most of them already have on their shelves a complete supply of records made by the Philadelphia Orchestra, but promotion is by no means limited to Stokowski's own records.

STOKOWSKI CONCERTS

April 13	Hartford
April 14	Boston
April 15	Springfield
April 16	Toronto
April 17	Chicago
April 18	Urbana, Ill.
April 19	Evansville, Ind.
April 20	Atlanta
April 21	New Orleans
April 22	Birmingham
April 23	Little Rock, Ark.

April 24	Dallas
April 25	El Paso
April 26	Phoenix
April 27-28	Los Angeles
April 29	Santa Barbara
May 1-3	San Francisco
May 5	Salt Lake City
May 6	Denver
May 7	Holdrege, Neb.
May 8	Omaha
May 9	St. Louis
May 10	Minneapolis
May 11	Milwaukee
May 12	Cleveland
May 13-16	Ann Arbor
May 17	New York

SALES DRIFT

★ Springtime hits the record counters with a sharp little impact and nobody needs to be discouraged.

Certain sales-moves on the part of dealers have received notice as being as valid as ever in the warm-time of the year. A few pessimists may see their good customers deserting their interest in music and flocking to miscellaneous pleasures of the out-of-doors, but wise optimists will continue along the road of alert merchandising and let their gestures fit in where they will among the higher temperatures.

At the Trinity Talking Machine Co., New York City, where Paul Sonnenthal holds forth as record seller of good standing, there are some smart sales theories in practice.

Interesting aspect of the sales procedure at this store is that record-plugger Sonnenthal does not happen to be a gent who spent his life in the world of music, and yet he is able to handle his high-brow customers in an effective fashion. He has kept his eyes open to what has been said on recorded music in the prints, whether it's manufacturer's literature, musical magazines, or current concert work on the stage.

By this time, if an adventurer comes into the store and asks for Beethoven's Tenth Symphony, he is gently told that the composer wrote only nine.

Dealer attitudes

There is the feeling at this shop, as at others, that a deal of folks are blissfully unaware of the fact that records are still being made, sold and appreciated by the millions. To this end, and to publicize the "combination" as a master instrument, Trinity Co. keeps a fine Capehart placed well up to the front of the store. When prospects are wandering about the place, buying other items, they are likely to notice one of the managers in the act of putting a record on the instrument, without making any comment to the customer unless asked for one. It is possible in this way to stir up considerable interest with very little effort, as the customer is very often attracted to the goings-on.

Best sellers as we go to press

BRUNSWICK

It's Been So Long—Fox Trot. **You**—Fox trot. Both from the film, "The Great Ziegfeld," both with Freddy Martin and his orchestra—7631.

Gloomy Sunday—Fox trot. **Desire**—Fox trot. Both with Hal Kemp and his orchestra—7630.

Love Is Like A Cigarette—Fox trot. **Kissin' My Baby Good-Night**—Fox trot. Both with Duke Ellington and his orchestra—7627.

DECCA

Will I Ever Know—Fox trot. **Za Zu Za**—Fox trot. Both with vocal chorus and both with Jan Garber and his orchestra—732.

Christopher Columbus—Fox trot. **Froggy Bottom**—Fox trot with VC. Both with Andy Kirk and his Twelve Clouds of Joy—729.

If You Love Me—Fox trot with VC. **My Dear**—Waltz with VC. Both with Jan Garber and his orchestra—733.

VICTOR

It's Been So Long—Fox trot. **Goody Goody**—Fox trot. Both with Benny Goodman and his orchestra—25245.

The Panic Is On—Fox trot. **Sugar Rose**—Fox trot. Both with "Fats" Waller and his Rhythm—25266.

Mad House—Fox trot. **Between The Devil And The Deep Blue Sea**—Fox trot. Both with Benny Goodman and his orchestra—25268.

Is your pulse strong and steady?



JUST as the human pulse is dependent on proper heart action, so the carrier frequency of your transmitter is dependent on the proper functioning of its crystal.

Crystals mounted in holders made of ISOLANTITE generate frequencies of greater amplitude and precision than where other insulating materials are employed.



Actual comparison in performance between crystals mounted in holders of ISOLANTITE and of organic materials has shown more than 75% increase in transmitter output where ISOLANTITE was employed.

Avoid frequency drift and assure increased output by insisting on ISOLANTITE crystal mountings. Isolantite, Inc., 233 Broadway, New York, N. Y. Factory at Belleville, N. J.

Isolantite
CERAMIC INSULATORS

ANTENNAS THAT GIVE SET A CHANCE

Customers' radios need new aerials to reduce noise

★ CHIEF reason for employing an outside antenna with modern radios is that of noise reduction or elimination. While the new sets have plenty of sensitivity or pep, just a wire run around the room or apartment is not satisfactory—noise from electric light switches and appliances may make enjoyment of radio's fine programs impossible. Consciously or subconsciously the owner's reaction is to limit the use of his set if noise prevails.

Proper antenna installations—pushed by both the radio dealers and servicemen—will provide mutual benefit. Sets will stay sold, servicemen will make more profits, and the customer will be satisfied.

Noise elimination

Experience of one New York retailer selling more than 100,000 sets a year, is that over 30 per cent of all the customers' complaints are the result of noise and improper antenna systems.

Main idea behind any aerial installation is to obtain signal pick-up in an area that is comparatively free of noise and to employ a transmission line to bring the radio program to the set without introducing any additional noise.

The common type of antenna employing a single-wire lead-in to feed the signal from the antenna proper to

the set, will pick up local noise through the lead-in system. However, such an installation is many times better than a wire tacked to the picture moulding, for the major part of the pick-up is in a noise-free area—in many cases it is entirely satisfactory. The extra signal pick-up allows the set to be operated at a lower sensitivity level which usually gives better tone quality and less tube hiss.

200-foot antennas

Simons Radio of New York, whose installations of master and single-set antenna systems serve tens of thousands of sets, recommend the longest possible aerial for noise reduction. "—it should be at least 200 feet long to raise the signal level—especially on direct current for complete noise elimination. Doublet types of antennas have not been found so satisfactory (referring to standard broadcast reception.—Ed.) in noise reduction as long flat-top antennas with a twisted pair transmission line. Our experience has been that the old Philco 'Three purpose antenna' with an additional 200 feet added to the flat top makes an unbeatable combination—unfortunately they are no longer manufactured."

Other service organizations in the New York area find that commercial doublet is very satisfactory from the point of noise reduction as well as

foreign short-wave reception. Opinion as to the best make of all-wave system varies greatly—it seems as though the make of the set has some influence on the matter.

Not a few servicemen still fail to understand the principle of noise reducing systems. It is obvious that for noiseless reception, the antenna must be placed in a comparatively noise-free area where it can pick up the radio signal without also collecting noise. This idea is incorporated in all types of antennas—whether they be doublets with transposed lead-in or a single wire run from the house to a nearby tree or building. The latter type—because it will pick up a signal and noise throughout its entire length—is useless in the case of strong local noise; that is the reason for transposed lead-ins and doublet systems.

Practically all doublets have a matching or coupling transformer where the lead is connected to the flat top—this coupler serves to transfer the energy from the aerial to the transmission line with the lowest possible loss of signal strength. In some systems it also serves to make the antenna exceptionally efficient at those wave lengths used for foreign short-wave broadcasts.

Transposed lead-ins

The advent of all-wave sets made the shielded type of lead-in obsolete—today's systems use a two-wire transmission line—of either the twisted-pair type or the transposed type using transposition blocks. These lead-ins are immune to both noise and radio signals—when noise reaches the line it is picked up by both wires, but it cancels out or disappears when it reaches the set since the noise picked up by one wire of the lead-in is equal and opposite to that picked up by the other wire.

The losses in a good transmission line are quite low even on the highest frequencies. The type with wires separated several inches employing transposition blocks at short intervals is best from the viewpoint of highest efficiency, but it is more difficult to install, more expensive, and to many customers is an eyesore. Twisted-pair lines are more practical—however, do not expect to get good results from ordinary telephone wire or lamp

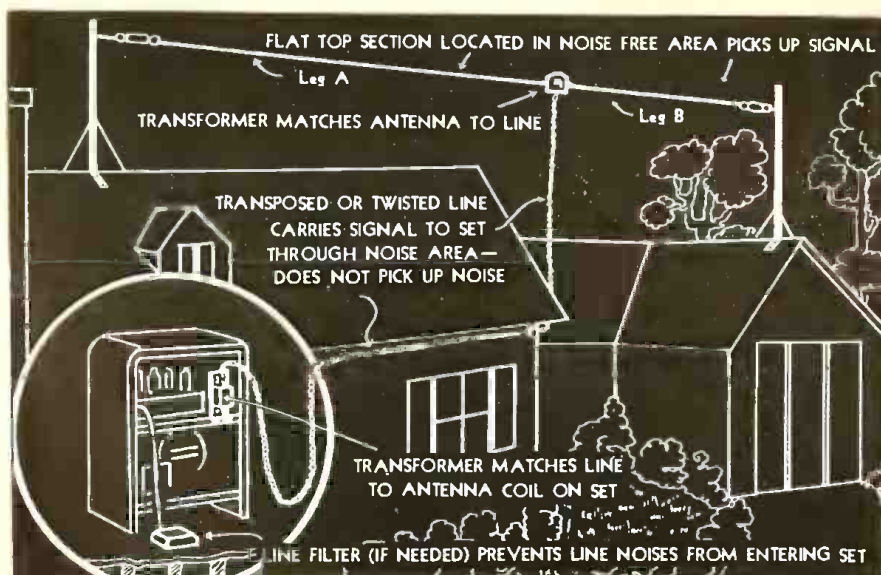

An all-wave antenna properly installed will reduce noise to negligible value and permit foreign reception with clarity. Legend explains operation of system.

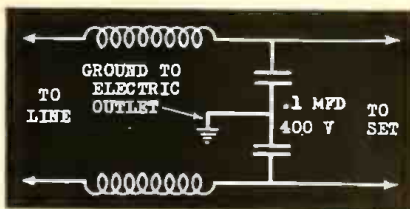

Circuit for low-cost line filter. Coils are 60 turns of No. 24 wire on inch form.

cord—use standard all-wave transmission lines designed to operate with the coupling transformers employed. Ordinary twisted pairs may have large losses and often are not properly waterproofed.

Many of the latest sets have two sets of antenna connection—one for the usual type of antenna and the other for a doublet system. With such a set the line-to-set coupling transformer is not required, but if the set was not designed for a doublet such a coupler will be required.* This transformer matches the line to the set and transfers the radio signal with the highest efficiency possible.

Locating antenna

Installation of a doublet antenna is quite simple, and satisfactory operation will result if a few common sense rules are held to. First, the doublet should be placed as far away from the noise sources as possible—this is usually done by placing the antenna on masts or poles above the house or running it between supports which are as distant from the house as is practical. The two legs of the doublet should be stretched out and hang clear of all obstructions.

If sufficient space is not available—do not run part of the doublet flat top up or down the side of a building. If the legs are equal in length—trim an equal amount from each leg so that the doublet can be stretched out. On unequal doublets, it is recommended that the surplus length be cut from the longer of the two legs.

However, pruning the doublet itself should be done only as the final recourse. Ordinarily it should be possible to find a clear space of some 60 to 70 feet. Usually it is possible to obtain permission to cross and even erect an antenna on neighboring property if the matter is handled tactfully. A superficial examination and a new tube placed in the neighbor's set will often do the trick—but be sure to add the cost of this to the antenna installation fee.

The radio coupler should always be mounted at the set—usually screwed

*Most all-wave kits have a line-to-set coupling transformer.

to the inside of the cabinet. And if the line supplied with kit is not long enough to reach to this coupler—buy additional wire—do not experiment with makeshift arrangements. If the lead-in has to be spliced for any reason, take care so that the splices are waterproof, for moisture will cause unnecessary losses.

Ground connection

Many servicemen overlook the necessity of a good ground and consequently the antenna installation does not eliminate the noise sufficiently. Every set should be well grounded (with the exception of certain AC-DC sets). A good ground is as important as the antenna. As a matter of general practice it is well to try the various convenient grounds to discover which one works the best. Possible grounds are: house wiring outlets, steam pipes, drain pipes, water pipes, metal framework of building. Remember, a poor ground can cause plenty of noise and intermittent operation of set.

Line filters

Sometimes a good antenna fails to reduce the noise sufficiently—usually the existing noise comes in over the power line. For all-wave sets an inductive-capacitive line filter is desirable—the serviceman has any number of commercial types to choose from. Simons Radio have found that for AC sets a filter can be made for

a very small cost. They employ a filter wired as shown in the accompanying diagram. The coils are 60 turns of No. 24 wire on an inch form.

The ground is usually made to the lighting system, but it is advisable to test the ground by connecting a bulb between the high side of the line and the outlet box. If the bulb lights normally, the ground is okay. This filter will take care of light clicks, motors, elevators, and ordinary sources of noise. When mounted in a suitable container, it presents a commercial appearance—yet its cost is less than a dollar.

Master systems

Apartment houses are always good prospects for antennas for there is usually a lot of local noise. Many times the tenants do not desire to spend much for an aerial and just string any wire on the roof. As a result there is a maze of wires—not one properly installed. This haphazard mess usually increases the maintenance cost of the house—the roof always needs repairs, leaks spoil ceilings, and walls, flashing wears out soon because the wires rub against it. The serviceman can use these arguments effectively in selling master antenna systems.

Tracking down noise in apartment houses often is a great problem. One local organization employs a portable set (RCA 26) with an exploring coil. This coil, which is connected to the set, is wound on a form just big



Installations on apartment houses require a well-trained serviceman. Servicemen are shown installing a Taco master aerial system. Performance and reliability are paramount in this type of work.

Step with KADETTE

With KADETTE you'll always be a step ahead of your competitors because Kadette gives you the new things first. Examine the modern Kadette line—compare with what you are now selling—then step into the profit parade with Kadette.

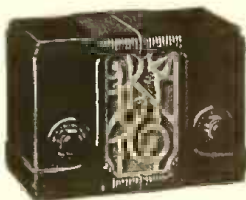

KADETTE Jewel

The original and most beautiful AC-DC compact in the world. Encased in gleaming scratch-proof bakelite with exquisite grille settings representing precious stones. A wide selection of colors for all room settings. Size: Only 3 1/2" x 7 1/2" x 3 3/4". Weight: Only 3 3/4 pounds.

Model 41—Walnut Bakelite . \$13.50
 Model 43—Deluxe Ivory Plaskon 16.50
 Model 44—Deluxe Red Plaskon 16.50
 Model 47—Deluxe Black Pearl. 16.50
 Model 48—Deluxe Marble . . 16.50

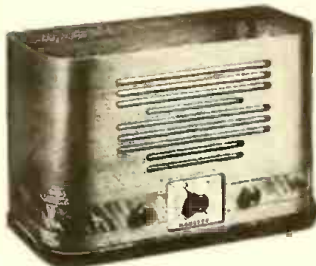

KADETTE Sixty-six

Powerful Six Tube AC-DC Superheterodyne tunes all police calls, amateur, airplane and standard broadcast bands. Beautiful moderne design cabinet of American walnut with oriental walnut inlay. Polished black ebony finish base. Sharply selective, amazing performance, natural full tone. Size 13 3/4" wide, 9" high and 6" deep. Weight 8 pounds.

Complete with tubes \$19.95

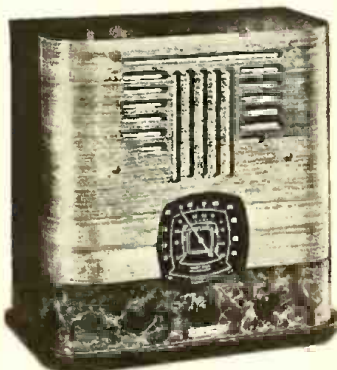

KADETTE "77"

A new, powerful, seven-tube long and short wave superheterodyne. Two distinct tuning ranges, 560 to 1500 kilocycles and 5.5 to 15.5 megacycles covering complete standard broadcast, foreign and domestic short wave. Extra-large airplane dial, with vernier drive, convex crystal enclosed. Powerful, electro-dynamic speaker. Sharply selective, with full, rich, thrilling tone. Beautiful modern cabinet, sliced American walnut; genuine burl walnut inlay. Knobs and base black ebony finish. Size 12 1/2" high, 11 1/4" wide, 6 1/4" deep. Weight, 10 pounds. Complete with tubes, \$26.95.

And the Completely Portable



KADETTE Battery Radio Model 400

Standard broadcast and short wave. Equals "electro-dynamic" performance because of revolutionary new Perm-O-Flux permanent dynamic speaker. Amazing lifelike tones, excellent selectivity. Operates approximately 300 hours from three ordinary ignition dry cells and three portable "B" batteries, self-contained. Modern cabinet of American walnut. Size 16" wide, 7" deep, 10 3/4" high. Aerial and ground attached, completely portable, wt. 25 pounds. With Batteries and Tubes, \$29.95.

THE INTERNATIONAL KADETTE

Write for full information on the quick selling, profit-making Kadette line
**INTERNATIONAL RADIO CORPORATION, 506 FOURTH STREET
 ANN ARBOR, MICHIGAN**

BETTER ANTENNAS

(From page 27)

enough to fit over a standard lighting fuse. If it is suspected that the noise is in the house, the coil is placed over the fuses—then if it is found that there is more noise on one particular line, the fuses of that line are removed. If the noise stops, it means that there is some noise originating in that particular apartment and steps are taken to correct it.

Noise sources

Noise has been found to originate in most cases from very common sources, such as, defective lamp cords, defective sockets, worn-out light bulbs, and poor contacts between appliance plugs and convenience outlets. Occasionally tropical fish aquariums with thermostats, oil burners, heating pads, and the like cause difficulty. Vacuum cleaners, electric mixers, flat irons, and other similar appliances can be troublesome, but fortunately their use is rather infrequent.

Too much stress can not be put on installing an antenna in a careful manner—masts should be securely fastened and guyed and painted. If the job is done in a slipshod manner, the owner will fail to be impressed with the serviceman's work. "A good impression and satisfactory operation will do more to build a reputation than anything else—and at the same time you can command a good price for your work," is the advice of successful antenna experts.

"STRANGE COINCIDENCE" DEPARTMENT

★ "Simple, effective, inexpensive means of modernizing any set by adding electron-ray feature for precise visual tuning. Especially desirable for those good sets lacking tuning meter, shadow meter, neon tube, or other visual tuning indicator. Installed in an hour or less. A real profit-maker for the serviceman."—From bulletin issued Jan. 22, 1936, by Technical Appliance Corporation, New York.

"Simple, effective, inexpensive means of modernizing any set by adding electron-ray feature for precise visual tuning. Especially desirable for those good sets lacking tuning meter, shadow meter, neon tube, or other visual tuning indicator. Installed in an hour or less. A real profit-maker for the serviceman."—From circular received March 17, from Autocrat Radio Co., Chicago, Ill.



INSULATED RESISTORS PIONEERED *by* IRC

The INSULATED RESISTOR had its origin in the pioneer work of International Resistance Company

The RECORD

- 1931-33 Period of creative research and practical development.
- 1934 Limited production started late in year. Entire capacity sold **OVER 1,000,000 INSULATED UNITS.**
- 1935 Increased manufacturing capacity. Sales increased to more than **20,000,000 INSULATED UNITS.**
- 1936 New plant and equipment—Sales first quarter compared with same period 1935 **400% GREATER.**
- TODAY** The IRC Insulated Resistor has created new design practice, now universally accepted.

INTERNATIONAL RESISTANCE COMPANY
401 North Broad Street, Philadelphia, Pa.

Factories or Licensees in

CANADA ENGLAND FRANCE GERMANY ITALY DENMARK AUSTRALIA

PHILCO MODEL 655

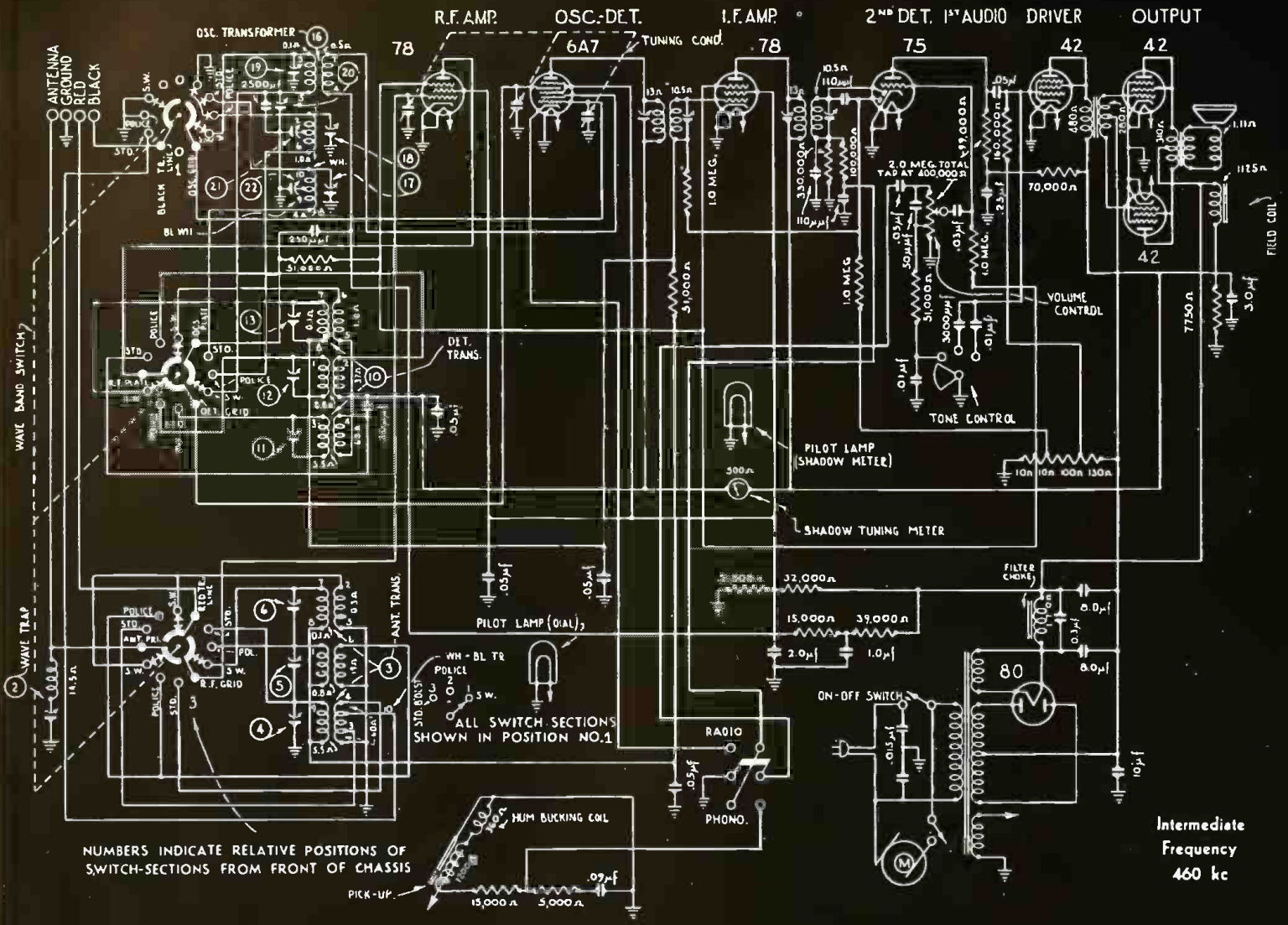

GENERAL ELECTRIC MODELS A-83, A-85

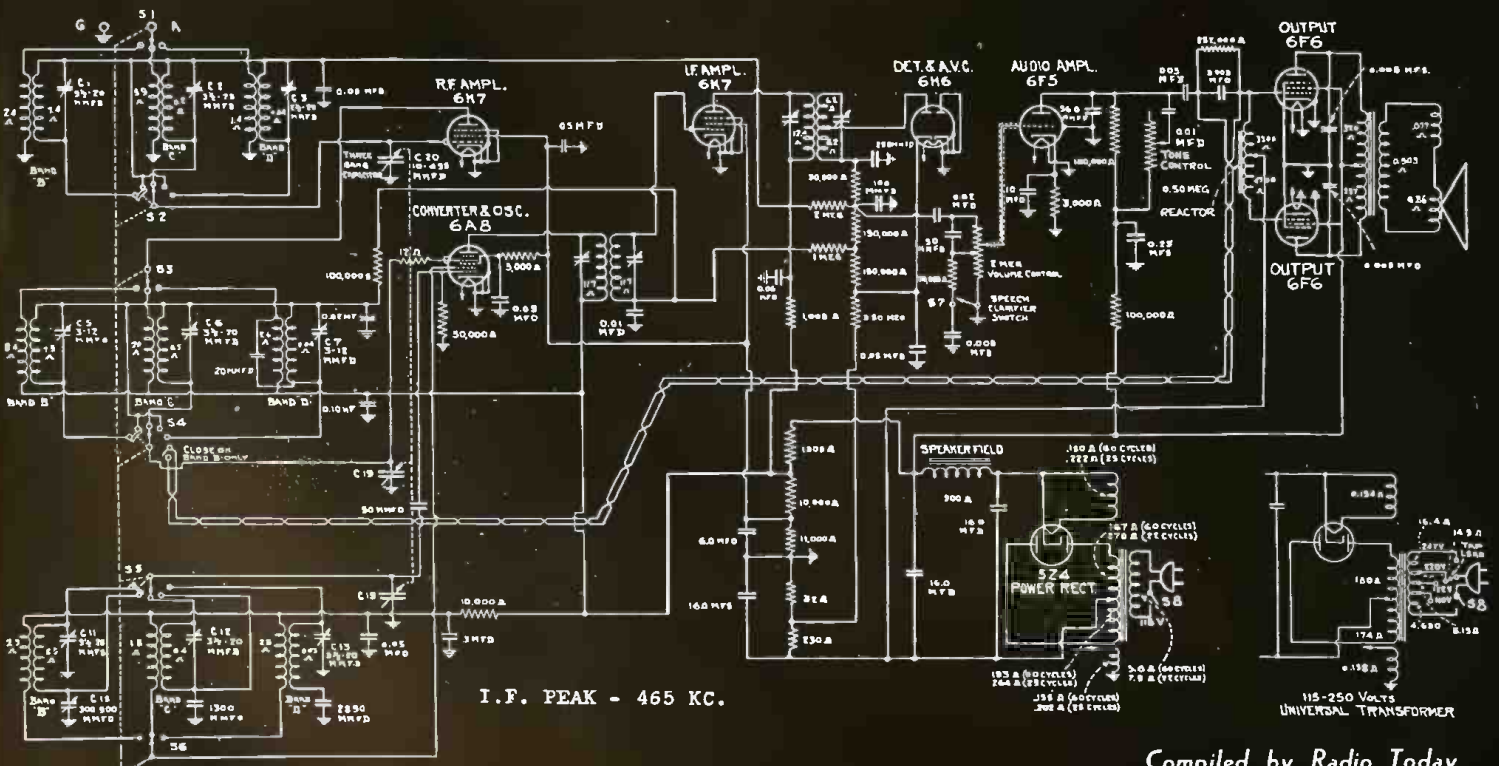

Thank You Gentlemen!

OUT ONLY 60 DAYS!

Already
A SENSATION!

PERM-O-FLUX

PERMANENT
Dynamic MAGNET
Speaker



A New **RADIO** Engineering Development

by **Continental Motors**

THE radio industry has given PERM-O-FLUX instant recognition. The announcement of a speaker using a permanent magnet which is efficient and permanent enough to equal or better electro-dynamics speakers of equal size has proved PERM-O-FLUX to be a distinct sensation. Employing a new magnetic material developed, perfected and manufactured in the laboratories of Continental Motors Corporation, PERM-O-FLUX has a source of magnetic energy that is the most

powerful yet known to metallurgical science for radio speaker application.

PERM-O-FLUX also offers a new type of voice coil suspension. Suspended at both ends, the voice coil is held absolutely parallel, eliminating any possibility of rubbing in operation, a patented Continental feature.

Continental PERM-O-FLUX speakers offer true reproduction, maximum efficiency and superior tone qualities in all ranges. Completely dust-proofed, PERM-O-FLUX speakers simplify installation difficulties. In automobile installations, shielding of the speaker is unnecessary.

PERM-O-FLUX speakers have a permanent flux density in the gap requiring no outside energy for field excitation, thereby reducing battery drain.

Now available in many models and sizes. Complete literature furnished on request.

35,000 MAGNETS—This unretouched photograph shows a corner in the magnet department of PERM-O-FLUX Division of Continental Motors Corporation, at their Detroit Plant. In this view are 35,000 PERM-O-FLUX magnets undergoing final inspection.



Continental Motors Corporation

Radio Speaker Division—10801 EAST JEFFERSON—DETROIT, MICHIGAN

HOW TO MAKE MORE MONEY—

Tie-in with RCA Check-Up Campaign

IN YOUR LOCAL NEWSPAPERS

Is your radio an old grouch?
Does it grunt and growl splutter? Then the first thing you need is a \$1.50 Radio "Check-Up"—a standard service that locates the source of complaints and frequently cures it in the operation. Tubes and parts (needed) are extra, but you know what they will cost you start. For curing grunches, get a "Check-Up."

Is your radio weak in the knees?
In other words, does it plod on old tubes? Does it sound awful? No need for this when you can have a Radio "Check-Up" for \$1.50. It includes not only a complete inspection, but the curing of radio's little ills—loose connections, dirty parts, etc. Get a "Check-Up."

"DOCTOR for sick radios"
When your radio is sick, let a radio doctor just as you let your family physician for real illness. Let an expert do it! Complete Radio "Check-Up," top to bottom. A to Z, costs only \$1.50, plus any tubes or parts that may be needed to put your set in perfect health. Send for your RADIO DOCTOR TODAY

SQUAWKS TAKEN FROM RADIOS
If your radio is a year old or more, very likely it squawks. Any radio develops a cough unless it is serviced once a year.

A MILLION FOR A CENT!
Like any other modern device, a radio needs service once in a while if it is to work perfectly. Here's the big bargain in radio service—the RCA \$1.50 Radio "Check-Up"—comprising a complete inspection and the minor adjustments that often mean a major improvement in reception. Tubes and repairs are extra, but cost little in comparison with the value of the entertainment they bring. Thus for pennies a week you get protection worth millions. Do it now!

DEALER NAME
WE RECOMMEND RCA RADIO TUBES

THE RCA Check-Up Campaign is now going full blast in local newspapers in over 100 trading centers. Thus the magazine advertising on the Check-Up that has been running since last Fall in the Saturday Evening Post and Collier's is again re-enforced right in your own papers. Already dealers everywhere report enthusiastically on results. They are getting their own Check-Up mats free thru their RCA Radio Tube Distributors to run in their local papers. The Campaign brings them new business on tubes, sets, refrigerators—everything they sell. Ask your RCA Tube Distributor how you can tie-in with the campaign and make it make the most money for you.

*For money-making ideas, attend RCA Service Meetings.
Ask your distributor for dates.*



ARE YOU USING THE RCA SERVICE TIP FILE?

One look at the new RCA Service Tip File, and you'll want it. Contains tips on servicing sets, each tip on a separate card, indexed by make, model, and nature of trouble. Also many shop hints. Worth a lot of money to you in time saved on perplexing jobs. It's yours for less than the cost of the steel filing cabinet alone! Ask your RCA Radio Tube Distributor for details.



Radio Tubes

RCA Mfg. Co., Inc., Camden, N. J., a Service of Radio Corporation of America

SERVICING NEW CIRCUITS

PHILCO 655 SERVICE DATA

★ Diagram on page 30 shows circuits and parts values of Philco's new model 655. Circuit also shows connections for phono pick-up and turntable.

Trimmers are numbered both on schematic and on chassis layout for identification. Latter gives frequencies at which trimmers should be adjusted.

Philco recommends alignment in the following order—460 kc., I.F. (29, 31, 24, 26) and wavetrap (2)—Short-wave at 18,000 (6, 13, 19); at 6,000 (20); at 18,000 (19)—police at 5,500 (18, 5, 12); at 1,800 (21)—standard wave at 1,500 (17, 4, 11); at 600 (22).

CIRCUITS AND ALIGNMENT DATA FOR G-E MODELS A-83 AND A-85

★ Accompanying chassis layout of General Electric's A-83 and A-85 models shows location of antenna, r-f., and oscillator trimmers. Letters refer to band, condenser numbers refer to trimmers shown in schematic on page 30, and the frequencies shown are those at which trimmers should be aligned.

G-E recommends alignment in the following order: 465 kc. i-f.—Band B, 1,500 kc., (C-11, C-5, C-1); 580 kc., (C-15)—Band C. 5,220 kc., (C-12, C-6, C-2)—Band D, 18,000 (C-13, C-7, C-3).

Note should be made of the speech clarifier system controlled by switch S-7—switch is closed for speech,



Underside view of G-E A-83 and A-85 sets giving alignment frequencies and location of padding condensers.

rendering it very understandable. Of interest is the tone compensator which is operated by the wave-band switch and gives better response on the broadcast band—it can be readily found on schematic by following the transposed leads.

FOR BETTER RADIO BUSINESS

★ "Another source of revenue for the serviceman is the 'depression radio,' or the radios manufactured between 1932 and 1934. This period was the peak of the depression and most of the manufacturers were trying to outdo their competitors in building a cheaper set. Even some of the large manufacturers went after this business. Their radios are nearly all giving trouble

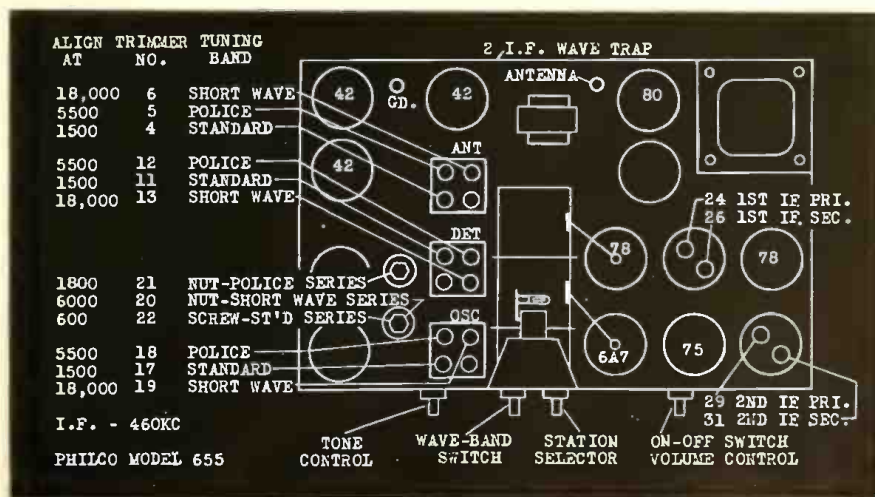

Chassis layout of Philco 655 showing trimmers and alignment frequencies. Complete schematic diagram of set shown on page 30.

ANNOUNCING a new low-priced CATHODE RAY OSCILLOGRAPH made by **DUMONT**

Allen B. Dumont Laboratories, Inc.

The oldest manufacturer of cathode ray oscillograph equipment in this country. Have pioneered many exclusive features.



PRICE
\$7450

NOW, with a new and simplified unit at the lowest price ever listed for a cathode ray oscillograph DUMONT gives a big impetus to this new method of servicing.

Low price, simplified control and complete performance—these are the features of the new type 154—now ready for radio servicing after 5 years of development in professional and college laboratory service.

Type 154 performs every important function of an oscillograph in service work and has many exclusive features. A single amplifier suffices for alignment, flat-topping of IF circuits, measuring hum and distortion, checking audio quality, etc. Calibrated scale supplied with unit.

SWEEP CIRCUIT—The patented Dumont sweep circuit is the most linear sweep yet devised. Utilizes the discharge of the condenser rather than the charge. The only commercial 3-in. oscillograph having a pentode tube as a constant current regulator. Sweep has widest range, enabling observation of waves from 10 to 1,000,000 cycles. Extremely rapid return trace; fast starting and stabilizing sweep. Sensitivity, .75 volts per inch of deflection, giving large images from low voltages.

AMPLIFIER—Highest gain yet offered in any commercial oscillograph. Voltage gain 100 between 10 and 100,000 cycles; 25 at 1,000,000 cycles. The only portable 3-in. oscillograph so designed that signals may be applied directly to the deflector plates enabling measurement of DC potentials or very high frequency patterns.

CONTROLS—All on front panel. Single knob control of signal input voltage, sweep voltage, frequency, amplitude and focusing.

POWER SUPPLY—Completely AC operated from 110-120-volt mains.

SEND THIS COUPON

ALLEN B. DUMONT LABS., INC.
Upper Montclair, New Jersey

Send free bulletin 154 to

RT-1

NAME

STREET

CITY..... STATE.....

COMPANY TITLE or POSITION.....

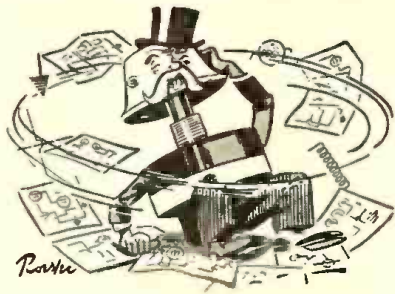

The Circuits go 'round & 'round

• Service any set with a song . . . no matter how involved the circuit . . . that is . . . if you've been tipped off to use CENTRALAB replacement parts wherever Volume Controls and Fixed Resistors are indicated.

Get off the "merry go round" of service headaches. Ask for and insist on CENTRALAB.

RADIOHMS

For smooth . . . noiseless attenuation . . . the ideal Volume Control replacement.

RESISTORS

Baptized in fire at 2500° F. Noiseless-moisture proof.

SUPPRESSORS

for top efficiency for both radio and motor.

The new 1936 VOLUME CONTROL GUIDE is out. See your jobber.

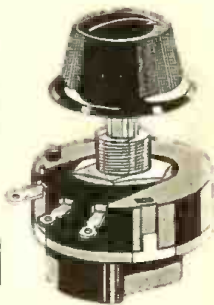

Every Radio Service Man should be a member of the Institute of Radio Service Men

Centralab

Milwaukee, Wis.

VOLUME CONTROLS
FIXED RESISTORS
SOUND PROJECTION CONTROLS
WAVE CHANGE SWITCHES

SERVICING NEW CIRCUITS

by now, and some of them have already lived their short lives.

"When you come in contact with one of these radios, don't ruin your own reputation by saying you can make it sound as good as new. You can't, and you know you can't. Explain to your customer the condition of the industry at the time the set was made, and let him decide whether he wants you to repair it or prefers to buy a new set."

—GEORGE CHAPMAN

President, RADIO TECHNICIAN GUILDS

SHORTED TUBES

★ When you find a tube with an internal short, check the bias resistor of that stage and the resistors in the circuits of the shorted elements. Often the overload imposed by short-circuit in tube will damage resistors.

HI-FI EXPANSION CIRCUIT IN FAIRBANKS-MORSE SETS

★ In their Models 82 and 100 Fairbanks-Morse employ a two-position high-fidelity control described as "third dimension tone."

I-f. expansion is obtained by employing i-f. transformers with a third winding which is closely coupled to the primary, thereby providing a wide band pass. Circuit is shown with the switches in "normal" fidelity position.

Note that in the "hi-fi" position the visual tuning meter is shorted—this means that the user of the set

must do the tuning in the "normal" position before expanding the i-f.

Alignment of the i-f. stages should take place in the selective or "normal" position of the fidelity switch. In general this procedure is followed in other sets with a fidelity control.

SALVAGING FLOOD-DAMAGED SETS

★ Disheartened will be the owner of a radio when he first looks at his set after it has been recovered from his water-soaked house—but often these sets are not a total loss, in spite of their appearance.

First of all, wood veneer cabinets are ruined by water—this gives the serviceman an opportunity to replace with a new style cabinet of customer's particular taste.

Before working on the sets, they should be dried out thoroughly and all mud removed. Particular attention should be paid to removing the silt from trimmer condensers, variable condensers, variable resistors, between voice coil and field poles. Drying can best take place in an overheated room.

Before connecting the set to power line, all condensers should be examined and checked for shorts and opens—if the paper has started to come off, replace the unit. Volume and tone controls of the coating-on-paper type will need to be replaced; wire-wound resistors with fiber insulation or construction should be checked carefully for shorts and proper resistance values.

Power transformers may have survived the wetting—but do not insert the rectifier tube until the transfor-

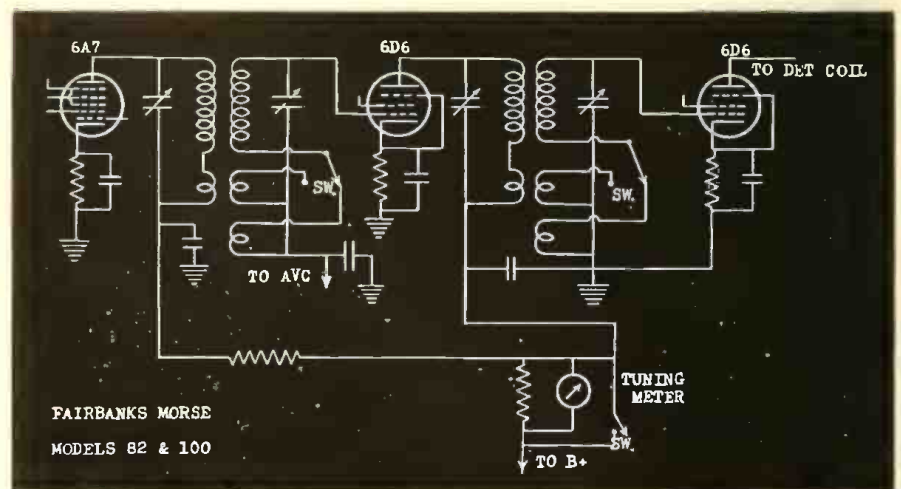

I-f. circuits employed in Fairbanks-Morse "third dimension tone" sets. A closely coupled coil permits a wide band pass—switch shown in selective position.

mer has been operating several hours as a check on its condition. Be sure that a small fuse is inserted in the line when testing these sets. If possible, it is safest to replace the transformer; but in the event it is found okay, wire in a fuse that will carry about twice the normal current of the set as a precaution against future trouble.

Sometimes it will be found that the speaker cone and assembly is okay if dried out slowly—but more usually it is hopelessly damaged. Best procedure is to replace entire speaker unit with its output transformer, for both the latter and the field winding may be in poor shape. Additional expense involved is not much greater than that of the cone itself.

After all parts and voltages have been checked, it may be found that set will not operate—it has been discovered by a large manufacturer that a damp oscillator coil is usually the cause. Alignment of i-f. and r-f. stages will be required in practically every instance.

It is the opinion of one manufacturer that any set, even in the lowest price class, is worth repairing. Fortunately the parts that need to be replaced in small sets are usually quite limited, for many of the sets have no power transformers and very few other parts.

Since the damages may vary from one extreme to another because of differences in degree of wetting and in construction of parts and sets, it is recommended that no estimate be given until the set has been thoroughly checked—allow for new transformers, speaker, cabinet, volume control, by-pass and filter condensers. And so that no loss will be incurred, a nominal charge should be made for examination in case set is not repaired.

INSTALLING WIND CHARGERS

★ Note from the Win-charger Corp. calls attention to necessity of properly locating the wind charger mechanism. Object of a good

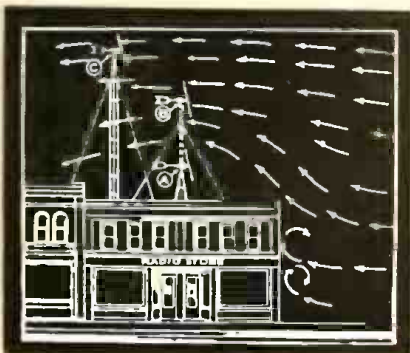

ANNOUNCEMENT!

Time Payments Now Available
on CLOUGH-BRENGLE Instruments

For as little as 33c per day you can completely modernize your shop on the new C-B "Pay-As-You-Earn" Plan. Ask your jobber or write for new booklet.

The CLOUGH-BRENGLE CO.

1134-X W. Austin Ave., Chicago, U. S. A.

A SENSATION

THE SYLVANIA TECHNICAL MANUAL!

IN JUST 30 DAYS . . . THE SYLVANIA TECHNICAL MANUAL HAS CAUSED A SENSATION AMONG RADIO MEN ALL OVER THE COUNTRY!

● And why not? It's the most complete and informative manual Sylvania has ever published! Here are just a few of the features of this book.

1. A 50% increase in contents.
2. 141 tube types listed with important circuit application information given on each type.
3. Characteristics on all types are the latest, including all the standard types of metal tubes.
4. A section on circuits has been increased to include 13 typical radio receiver and amplifier circuits which show proper use of the most popular types of tubes now being employed.
5. Curve data on ballast tubes for battery sets.
6. The convenient pocket-size has been retained in spite of the large increase in material.

Send 15¢ for this new Technical Manual now! It will mean cash in your pocket.

Hygrade Sylvania Corporation, makers of Sylvania Radio Tubes and Hygrade Lamps. Factories at Emporium, Pa., Salem, Mass., and St. Mary's, Pa.

SYLVANIA

THE SET-TESTED RADIO TUBE



HYGRADE SYLVANIA CORP.
Emporium, Pa. RT-46

Please send me the new Sylvania Technical Manual. I enclose 15¢ in stamps.

Name

Address

City..... State.....

10,000 RADIO PARTS



Parts to cover every radio need—get them from ALLIED. Fresh, clean stocks of highest quality—all at lowest prices. Order from the new ALLIED Catalog—Radio's Leading Supply Guide.

ALLIED RADIO
 833 W. Jackson Blvd. Dept. TR
 Chicago, Illinois
 Send me your FREE Radio Catalog.
 Name
 Address



Noiseless All-Wave ANTENNA SYSTEM

- ★ TACO No. 20 Antenna outperforms any other all-wave noiseless system, yet costs no more. (Only \$6.75 list).
- ★ Kit form . . . complete . . . factory assembled, wired, soldered . . . just string up!
- ★ Efficient in broadcast, police, amateur and short-wave bands.
- ★ Minimizes background noises . . . ideal for those "poor radio spots."

Write for technical and merchandising details on this fast-selling money-making item. Meanwhile, why not order one from your jobber and try it for yourself?

TACO
TECHNICAL APPLIANCE CORP.
 Pioneers in Noiseless Antenna Systems
 17 East 16th St., New York City



SERVICE NOTES

installation is to place the mechanism so that propeller will get the full force of any wind.

First diagram shows three possible installations atop a flat-roof building. That at "A" is useless because the wind is deflected upward by the wall of the building and passes over the wind charger. That at "B" gets almost the full force of the wind—"C" is the ideal installation but requires a tower.



Chart above illustrates good and bad installations on a typical farm house. Location "A" is ineffective on account of the trees, and the main air stream passes above the generator and produces a turbulence around the propeller. "B" shows an improved installation made by adding a length of pipe to the tower assembly. The tower set-up at "C" is even better than "B" for the full force of the wind is available.

CATHODE RAY TUNING FOR AC-DC SETS

★ Visual tuning of the cathode ray type is easily installed on the better AC-DC sets employing automatic volume control. Either separate parts or an electric eye tuning adapter can be employed.

Since the filaments in these sets are in series, it is a simple matter to break the circuit and wire in the filament for the 6E5 cathode ray tube which has a 6.3 volt, 0.3 ampere filament.

Because the tube represents an added resistance in the circuit—the dropping or ballast resistor must be reduced by 21 ohms. Its effective resistance can be easily reduced by shunting a 10-25 watt semi-variable resistor across it and adjusting until the current in the filament circuit is 0.3 amperes.

Formula herewith gives value of shunt resistance required—

$$R = \frac{R_1 R_2}{21}$$

where: R =shunt resistor
 R₁=original resistance
 R₂=R₁-21=desired resistance

Alternative is to replace existing resistor with one of required value (21 ohms less than original).

The plate of the 6E5 goes to the

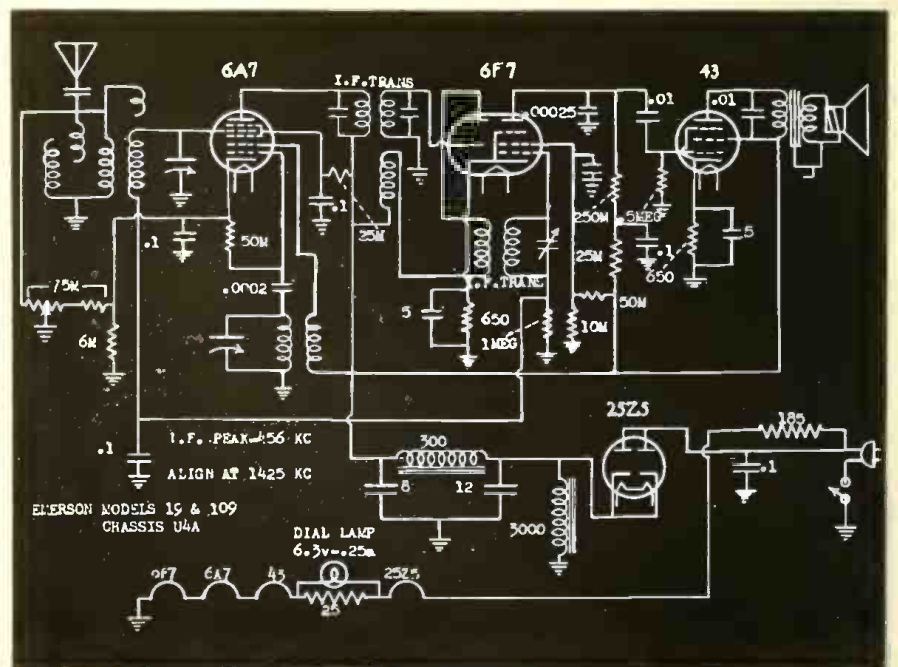

Complete schematic of Emerson's models 19 and 109. Triode i-f amplifier and pentode detector were discussed on page 28 of March issue.

B+ of the set, grid goes to AVC control voltage, while the cathode of 6E5 is connected to cathode of the diode detector. Heavy lines in accompanying circuit diagram show additions to original circuit. In other respects installation is same as with AC sets.

A little difficulty may be found with getting the 6E5 to glow properly because of the low plate voltage—try several tubes and use one that glows most brilliantly is advice of tube manufacturers. A small percentage of 6E5's will be found that

10 Watts Output



- 3-stage, 10 watt amplifier, using all metal tubes 1-5Z4, 2-6C5, 2-6F6 (furnished).
- Mixes microphone and phonograph.
- 2-button carbon microphone—stretched duraluminum diaphragm—banquet stand—25 foot cable.
- High grade 8 in. D.C. dynamic speaker. (System handles one or two speakers).



System C-10 is light, compact and economical. No external accessories such as batteries, are needed. Weight only 24 lbs. Suitable for store advertising, medium size theatres, churches, undertaking establishments, outings, lodges, banquets, etc. Handles crowds indoors up to 1,200 people; outdoors half this number or more, depending on conditions.

This system is very compact in size, light in weight, attractive and well constructed. Total weight complete, 24 lbs. Despite its light weight and small size, the powerful five metal tube amplifier gives this system unusual performance.

Fully Licensed - Strict Dealer Policy - Time Payment Plan FREE

"A Short Course in Sound Engineering" Webster-Chicago is now preparing a limited edition on the above. Every sound man, jobber, dealer, service man will want one of these up-to-date pamphlets covering engineering and sales details. If you wish one, send in your name. Printing will be limited to those desiring this information.

THE WEBSTER COMPANY
Section A-9 3825 W. Lake St.
Chicago, Ill.

Without obligation please send me
..... More information on System C-10
..... Copy of "Sound Engineering"

Name

Address

City..... State

require more than 100 volts for operation—these should be used on the AC installations where the higher voltage is available.

SHORT WAVE FADING

★ Fading on short waves may sometimes be caused by poor contacts and grounding of the gang tuning condenser sections. Remedy is to add ground leads or resolder the existing ones. Dirty and noisy rotor contacts should be cleaned with carbon tetrachloride (Carbena). Same trouble may be caused by corroded wave-change switches.

SHIPPING BOLTS

★ G-E service note advises that shipping bolts should always be removed when putting set into operation. On other makes of sets it may be necessary only to loosen these bolts—failure to do so may produce microphonics and howls.

PHONO CIRCUITS OF RCA-VICTOR D7-7, D8-28 COMBINATIONS

★ The RCA-Victor D7-7 and D8-28 combinations employ the same radio chassis respectively as the Models C7-6 and C8-19 described on page 25 of RADIO TODAY for March. The 7-tube model introduced last fall does not have the 6E5 magic eye and uses 80 rectifier.

Diagram accompanying this article shows additional circuits employed in

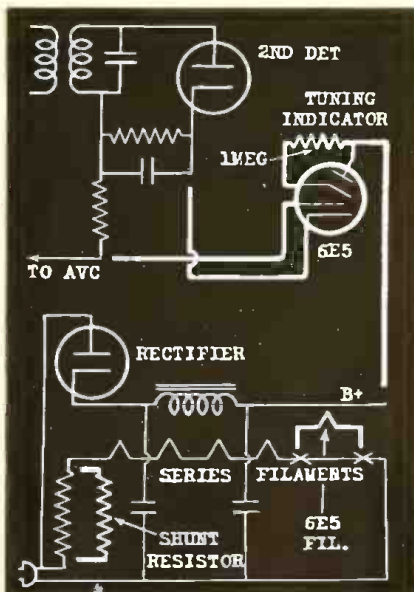

Heavy lines indicate circuit changes required for addition of cathode ray tuning to AC-DC sets.



Custom - built electric portables designed by the pioneer builder of automatic phono-radio combinations in portable cases.

A new Moneymaker for DEALERS

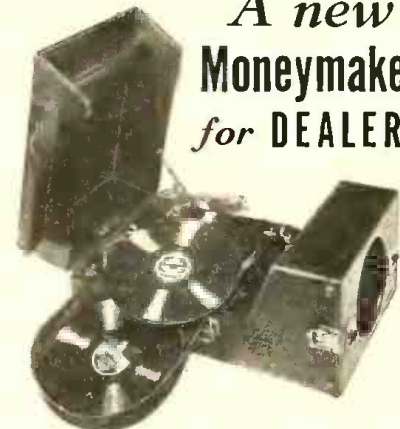

• The Harris Electrotone, a complete line of new, modern phonographs and phono-radio combinations of the portable type, offers a real opportunity to dealers. These superb instruments, meeting every requirement of quality, performance and price, and allowing a generous trade discount, offer a new merchandising advantage to the dealer capitalizing on the widespread interest created by the Harris Electrotone.

The eight models of this superior electric portable are masterfully designed in compact, beautifully modern cases. They afford a full, rich, melodious tone from either recordings or radio broadcast. Tone and volume are comparable to large console instruments; factory-tested for output and quality. Frequency range, 80 to 6,000 cycles. High fidelity reproduction of symphonies, operas, dance music and world-famous solo artists exactly as recorded.

The Harris Electrotone Line Includes:

- All-electric phonographs with push-pull amplifiers; 8" dynamic speakers, tone control, automatic stops; some with automatic record changers playing eight 10" or seven 12" records; built-in record storage compartments; improved 3 1/4 oz. crystal pick-up; designed for 110 volts AC, 50-60 cycles. Also Automatic for 110, 220 and 250 volts, AC-DC. List from \$79.50 to \$125.00.
- AC-DC phonograph for world-wide operation, all voltages from 100 to 250, either AC or DC; 5-tube amplifier; not to be confused with AC-DC instruments having limited operation possibilities. List, \$94.50.
- Phono-radio combinations with 7-tube super-heterodyne and all strictly modern features. Manual and automatic playing. Also deluxe models for AC and AC-DC operation on 110 volts. Also 110, 220, and 250 AC-DC. List \$99.50 to \$150.00.
- Automatic adaptors transforming present radio sets into automatic Phono-radio combinations. List \$65.00 to \$75.00.
- Record carrying cases matching Electrotone finish; capacity—thirty-five 10" to fifty 12" records. List \$6.00 to \$7.50.

WRITE FOR COMPLETE CATALOG AND DEALER DISCOUNTS 15 New Items To Be Announced in May

THE HARRIS MFG. CO.
2422 W. 7th St., Los Angeles, Calif.

Please send complete information to:

NAME

ADDRESS

CITY and STATE

Bank your Job Profits



• The Service Man who uses Ward Leonard Wire Wound Replacement Resistors does not have to waste his job profits making good resistor failures. You have known these resistors for many years and know they stand up. They are conservatively rated. The line is complete. Bulletin 507A gives a complete line of resistors with list prices. Send for a copy today.

WARD LEONARD ELECTRIC COMPANY MOUNT VERNON, NEW YORK

Please send me your new Bulletin 507A.
Name
Address
City..... State.....
Jobber's Name.....RT



Big News for all SERVICE MEN!

A SENSATIONAL new "Dependable" Analyzer is on its way—sensational in performance, sensational in price! Advance bulletins giving complete details are now ready. Get your copy at once. This is BIG NEWS—DON'T MISS IT! Mail the coupon below today!

RADIO CITY PRODUCTS CO. 88 Park Place, New York City

Please rush me your bulletin describing the NEW Dependable Analyzer.

Name
Address RT4

SERVICE NOTES

the phono-combinations — reference should be made to diagram of chassis published last month. The radio set is disabled during phono operation by opening the cathode of the 6K7 i-f. tube (SW-5).

For radio operation SW-5 is closed and variable tap on phone volume resistor rides onto a stud completing circuit from R11 to 6F5 audio tube. Circuit has been redrawn to show both types of operation.

Note that a universal transformer is employed only on the 8-tube model — turntable motor is permanently connected to 110-volt tap.

BOSTON SERVICE EXPOSITION MONDAY, APRIL 27

★ Radio Technicians' Guild will hold a parts and test equipment exposition on Monday, April 27 (10 a.m.-11 p.m.) in the Grand Ballroom of the Hotel Lenox in Boston. Door prizes will be awarded to lucky ticket holders at this meeting, the first of its kind to be held in Boston. An invitation is extended to all radio dealers and servicemen — admission is free.

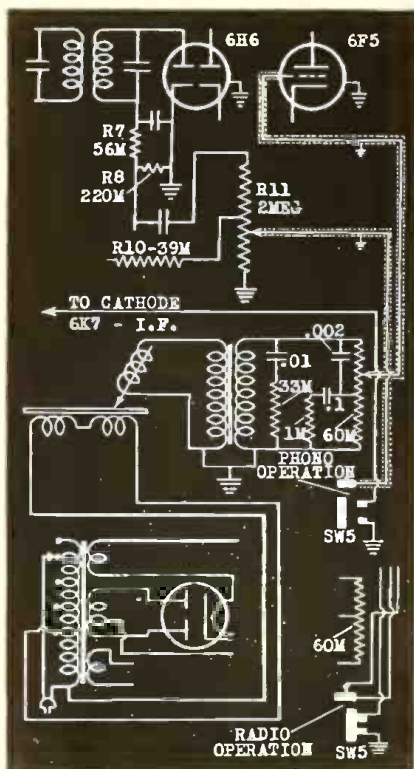

Note auxiliary diagram in lower right corner showing position of switches for radio operation of RCA-Victor's D7-7, D8-28 phonograph combinations.

Cornell-Dubilier HIGH Formation DRY ELECTROLYTIC CONDENSERS

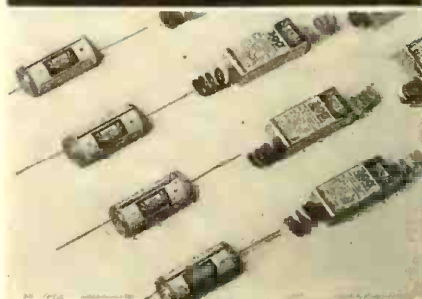

The QUALITY CONDENSER LINE for 26 YEARS

CORNELL-DUBILIER dry electrolytics are recognized for their

Long Operating Life • Minimum Leakage • Utmost Dependability • Long Shelf Life • Full Capacity • Inexpensiveness • Conservative Voltage Rating • Triple Seal Against Humidity and Abnormal Temperatures.

• For complete customer satisfaction and more business use C-D electrolytics. Ask your local C-D jobber about them. Complete catalog listing and technical data on request.

CORNELL-DUBILIER
CORPORATION
4360 BRONX BOULEVARD
NEW YORK

Great Interest Was Displayed

at the Chicago I.R.S.M. Show in the Na-Ald Socket Testing Machine.

Over one and three-quarter million contacts without failure and still going strong is the record of the Na-Ald "Tuning Fork" Contact Socket. Be sure that your instruments all use this socket. If not, we suggest changing so that you will not have contact failure at some inconvenient time.



Number	Type	List Price
424TF	4-Contact "T.F." Socket	.40
425TF	5-Contact "T.F." Socket	.40
436TF	6-Contact "T.F." Socket	.40
437TF	7L-Contact "T.F." Socket	.40
467TF	6-7L Contact "T.F." Socket	.50
438TF	8-Contact "T.F." Socket	.40
438TFE	8-Contact (1-11/16" centers)	.40
456TF	4-5-6 Contact "T.F." Socket	.50
467TF	6-7L Contact "T.F." Socket	.50
477TF	7L-7S Contact "T.F." Socket	.50

If you want the best Analyzer Plug obtainable get our 908CN Kit. Most compact — most dependable — most convenient to use. Write for literature giving complete information on this and other models.
908CN Kit List Price \$11.50

The Kit that requires the least time to install



You want the "eye" directly over the dial. Because of the small overall size of the connector and mounting foot which can be rotated, the most difficult space requirements are met.

Because it installs directly from the back and can be adjusted instantly from the back you can work fast and conveniently. — Meets Underwriters' requirements. — Bezel gives most effective brilliancy to sector. — Many servicemen making excellent profits installing this job.

No. 206FECHB Cathode Ray Tuning Indicator Outfit as illustrated with 24 in. cable and complete instructions less tube. List Price \$1.15

Na-Ald discounts to Jobbers are such as to insure your getting the fullest possible value for your money. Insist on genuine Na-Ald products.

Write today for new 1936 general catalog



ALDEN PRODUCTS CO., Dept. RT2
715 Centre St., Brockton, Mass.

WITH THE WHOLESALERS

★ **Simon Distributing Company** has opened very attractive headquarters at 1205 West Broad Street, Richmond, Va., for the distribution of **Motorola** products in that territory. This is a branch office of the well-known organization which has its main offices in Washington, D. C. **Otis C. Dorian, Jr.** has been appointed manager of the Richmond branch.

★ On April 1st, the jobbing organization of **Ditch, Bowers & Taylor**, Baltimore, celebrated its 100th anniversary and scores of congratulations were received from manufacturers of automotive and radio products. This well-known jobbing organization is a distributor of **Bösch** radio receivers and has a wide following among automotive dealers throughout the Baltimore territory. The officers of the company are **J. Mallory Taylor**, president, **W. McGrath**, sec'y and treasurer, and **W. A. Lamb**, vice president and general manager.

★ **Aerovox Corp.** has introduced an important device to simplify for jobbers the re-ordering of replacement condenser stock. Each **Aerovox** carton now carries red sticker with a hole in it, bearing the part number. Sticker is torn off and hung on a nail when the carton is sold; a glance at the accumulated slips at any time indicates how

many, and what, items have been sold. When jobbers are ready to re-order, numbers on these slips may simply be copied on the order form.

★ Newest jobber units of the 47-point distributing organization which **Stromberg-Carlson** has built up are: **Edwards & Walker**, Portland, Me.; **Graybar Electric** of Texas and Louisiana; and **Graybar Electric** of St. Louis.

★ New **Atwater Kent** distributor in Rhode Island territory is **North-eastern Radio, Inc.**, 85 Broadway, Providence. **AK** has also announced the appointment in Pennsylvania of the **R. B. Wall Co.**, 18 E. Market St. **Wilkes-Barre**, as a jobber for the company.

★ **Stewart-Warner Distributors, Inc.**, Washington, D. C., is the new corporation headed by **William Cohen** to distribute both radios and refrigerators for the **Stewart Warner Corp.** in the District of Columbia.

★ **General Electric Radio Division**, Bridgeport, Conn., has announced that a radio factory sales and service branch has been established at the **GE** warehouse, 585 Hudson St., New York City. New branch will serve as distributor for the metropolitan New York area, including **Westchester, Nassau** and **Suffolk** counties.

This move by **GE** is due to conditions which it considers peculiar to New York and is in no way indicative of a nation-wide policy. Sales directors of the new branch will be **Earle Poorman**, district manager of appliance sales, and **D. W. May**, district radio sales manager, whose offices, however, will remain at 570 Lexington Ave., N. Y. C.

(Continued on page 40)

COLORFUL PLUG



★ Gay-colored set of gadgets which gives dealers a boost in selling and demonstrating auto radio, has been prepared by **American Bosch**, 3664 Main St., Springfield, Mass. Besides a special panel display featuring custom styled controls, company offers a kit including a metal demonstration stand, window streamers, banners, and a set of 100 illustrated sales folders.

NEW CONVENIENT FLEXIBLE ECONOMICAL SPEAKER REPLACEMENTS

With New "Changeable Field" SPEAKERS by OXFORD



● Completely new and improved type of Electro-Dynamic Replacement Speaker! Permits quick, easy change of field coil to give you the proper combination of transformer and field for the "job" when you need it. Universal transformer matches any tube. Voice coil remains centered! Available in 6", 8" and 11" models.

Ask your Jobber—or write TODAY for Bulletin 361T
EXPORT DIVISION:
15 Light Street, New York, N. Y.
Cable: "ARLAB"

"ACCEPTED BY SOUND JUDGMENT"

OXFORD-TARTAN RADIO CORPORATION
915 W. VAN BUREN ST. • CHICAGO, U. S. A.



Exact Duplicate Controls

Don't improvise! It costs no more to do the job right. ● First, look up exact data in **CLAROSTAT** Volume Control Replacement Guide—most extensive listing ever released; second, use exact duplicate replacement specified. ● This ideal combination spells profitable servicing and lasting good will.

Free Guide. If engaged in servicing, write for **CLAROSTAT** Volume Control Replacement Guide No. 2. Your jobber can supply required units.

CLAROSTAT

MANUFACTURING CO.
Incorporated
285 North Sixth St.
Brooklyn, N. Y.



Send for Yours!

The **Radolek New 1936 Radio Profit Guide** is just off the press... completely revised—right up to the minute... Everything in Radio—at the right prices. Contains over 10,000 Individual Radio Repair Parts—hundreds of new items—a complete new selection of Radio Receivers, Amplifiers, Tools, Tubes, Books and Instruments. Everything you need—always in stock... ready for prompt shipment to you. This Big Radio Parts Catalog is FREE. Send for it! Rely on **Radolek for Radio**. **Radolek** endeavors to restrict distribution of The Profit Guide to those actively and commercially engaged in the Radio Business. Please enclose your Business Card or Letterhead.

RADOLEK

596 W. RANDOLPH — CHICAGO
Send me the **Radolek Radio Profit Guide** Free.

Name
Address
Serviceman? Dealer? Experimenter?

HERE'S MONEY MAGIC

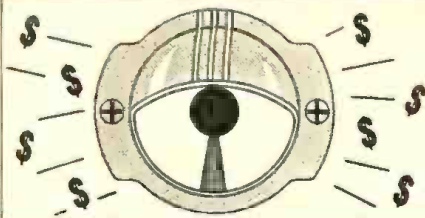

FOR SERVICE MEN

hurry! get full details on the

**NATIONAL UNION
CATHODE RAY
TUNING KIT OFFER!**

Free Post Cards on Every Offer to Create Sales. Send Coupon Now!

**NATIONAL UNION RADIO CORP. of N.Y.
570 Lexington Avenue, New York, N. Y.**

Rush Details of Tuning Kit Offer!

Name _____ RT436
Street _____
City _____ State _____

TODAY'S TRADE TOPICS

(Continued from page 39)

★ Interesting report on radio activity in Honolulu and surrounding Hawaii has been made by Edd N. Watkins, owner of the Electric Supply Co., jobbers of Oakland, Calif. Watkins has just returned from a 6 weeks trip to the Pacific islands, where he called on his dealer accounts and found a surprising amount of activity in radio and appliances, particularly in auto radio.

★ Roye Sales Co., 11 Warren St., New York City, has just been formed by Oscar and Martin Roye, both well-known throughout the radio industry in the East. The company represents several well-known manufacturers including Standard Transformer Corp., Meissner Manufacturing Co., Arthur Lynch Mfg. Co. and Consolidated Wire & Associated Corps.

★ Howard Richardson, formerly a sales executive with the Crosley Radio Corp., is now associated with the Taylor Electric Company, Milwaukee, well-known wholesale organization.

★ Stern & Co., Inc., distributors of Hartford, Conn., after having vigorously promoted Grunow products in Connecticut, Vermont and Western Massachusetts, have been awarded the additional territories of New Hampshire, Rhode Island, and Bristol County, Mass.

★ Newest merger among radio manufacturers has resulted in a powerful new corporation, all set with a heavy merchandising program and unlimited manufacturing facilities. Hallicrafters, Inc., Chicago, makers of communication receivers, and Case Radio Co., manufacturers of home receivers at Marion, Ind., have combined into a new company titled Case Hallicrafters Corp. The combine will operate the huge Case plant, turning out a complete line of home sets and Hallicrafter communication receivers. Officers of Case Hallicrafters Corp. come from executive boards of both original companies: W. J. Halligan, president and general manager; S. J. Thompson, vice-president; Robert Durett, vice-president; Arthur E. Case, treasurer; George Maselik, secretary. Mr. Thompson comes from the radio division of Montgomery Ward & Co.

★ Parker H. Erickson is the new sales manager of the radio sales division of Fairbanks, Morse & Co., home appliance section, Indianapolis. Erickson was advertising manager for Zenith Radio Corp. for the past several years and recently sales promotion manager for this company.

★ Banner baseball team, sponsored by the Clifford Bensinger Furniture Co., Crosley dealer of New Albany and Jeffersonville, Ind., and the Cooper Louisville Co., Crosley distributor, prepares to be a winner again this season by adding new players: Kenneth Bolt, Mert Taylor, Bob Solley, and Eddy Kunz.

★ Strengthened by a surprising seasonal sales volume in auto and home sets, Zenith Radio Corp. has leased another large building near its main plants in Chicago. New building at 3641 Iron Street has 100,000 sq. feet, giving company total of 350,000 sq. feet.

★ International Resistance Co. now occupies new top floor quarters at 401 N. Broad St., Philadelphia. This is IRC's fifth expansion move in 14 years; president Ernest Searing has announced also that a number of new products are soon to appear.

★ Halson Radio Mfg. Corp., 120 E. 16th St., New York City, has announced that Martin Openshaw is now in complete charge of the firm's export division. Openshaw is a vet traveler in the interests of radio.

★ C. L. Parris, president of Win-charger Corp., Sioux City, Iowa, entertained two guests extraordinary during a recent week at the Win-charger plant. One was E. C. Littler, of Melbourne, Australia, representing the J. B. Chandler Co., operators of an Australian network. Other guest was Capt. Y. C. Tom, Chinese radio engineer of Canton, China.

★ "Chick" Allison, veteran of the radio activities of the Skelly Oil Co., has joined the staff of Station KMBC, Kansas City, Mo., as promotion manager.

GUTHMAN Coils

WRITE FOR THE NEW GUTHMAN CATALOG TODAY!
There's a Guthman coil for every purpose! Get the complete, new catalog of new and replacement coils. Send for your copy TODAY!

EDWIN I. GUTHMAN and CO., Inc.
1036 West Van Buren St., CHICAGO, ILLINOIS

UTAH RADIO PRODUCTS CO. OAKLAND ST. CHICAGO, ILL.

Utah FLASH

URPC RT TWS CHICAGO ILL

NEW PROTECTIVE SALES AGREEMENT NOW GOING FAST STOP ONLY A LIMITED NUMBER AVAILABLE IN EACH COMMUNITY STOP SEND NOW FOR FULL DETAILS

UTAH RADIO PRODUCTS CO
CARRINGTON

TEAR OUT THIS AD—PIN TO YOUR LETTERHEAD AND MAIL TO DEPT. R. T. FOR COMPLETE DETAILS AND FREE CATALOG

★ Clarence B. Place is a new member of the sales department of Goat Radio Tube Parts, Inc., Brooklyn, N. Y., makers of tube parts and Form Fitting tube shields. Place was formerly with International Resistance Corp.

★ T. J. Manion is now associated with the Corona Radio & Television Corp. as general sales manager. Manion previously held the same position with Echophone.

★ Crosley Radio Corp. has issued the news that P. M. Jeffreys is the new district manager for the company in the states of Florida, Georgia and Alabama. Jeffreys' offices are at Atlanta, Ga.

★ W. Paul Jones, general manager of the home appliance division of Fairbanks, Morse & Co., reports that sales of FM's appliances for February were 25 per cent greater than for any previous month in the company's history. Mr. Jones points to increased production facilities at the new factory in Indianapolis, and a great many recent distributor and dealer appointments.

★ At a recent meeting of the board of directors of Station WOR (Bamberger Broadcasting Service, Inc.), Theodore C. Streibert was appointed vice-president. Mr. Streibert was also recently elected first vice-president of the Mutual Broadcasting System, and was reelected to the MBS board of directors.

★ General Electric's new district manager of radio sales is B. C. Bowe,

who will have headquarters at St. Louis, Mo. Mr. Bowe has been a GE man since 1909, and prominent in the company's radio activity for the last 6 years.

★ New district manager for Crosley Radio Corp. in the Carolinas, Virginia, and sections of Kentucky and Tennessee, is John C. Ammona, of Atlanta, Ga.

★ Neff-Rogow, Inc., is the new advertising agency specializing in radio at 30 Rockefeller Plaza, New York City, recently launched by Walter J. Neff and William Rogow. These gents are vets of hundreds of radio campaigns, and have a combined experience of 18 years in every phase of agency and station operation.

★ RCA Victor's "Salescasting" contest, three months old among distributors and retail salesmen, is now beginning its second merchandise award competition. Such awards are made aside from the main prizes of the "Salescasting" contest and the current one is sponsored by Thomas F. Joyce, RCA-Victor advertising and sales promotion manager. Winners of the Joyce competition will receive 60 Gladstone traveling bags.

★ Better business has inspired A. M. Flechtelm & Co., condenser manufacturers, to move their office and factory facilities to new and enlarged quarters at 692 Broadway, New York City. Angus J. Walker is chief engineer and production manager.

★ Philco's president, L. E. Gubb, went to Atlanta, Ga., recently to reward the sales manager of the Charlotte, N. C., district for exceeding the district quota by the largest margin recorded any place in the United States. W. A. Allison for his work there got the prize, which is called the Larry E. Gubb trophy.

REFRIGERATION FEATURES

★ Answers to the query on page 46: Thriftype—G-E Hotpoint; Len-A-Drawer—Leonard; Revolv-it—Grunow; Len-A-Door—Leonard; Koldchest—Frigidaire; Baskador—Sparks-Withington Co.; Pelco—Portable Elev. Mfg. Co.; Baskadrawer—Sparks-Withington; Antifrost Clock—Sparks-Withington; Shelvatray—Crosley; Carrene-Grunow; Shelvabasket—Crosley; Touch-latch—Frigidaire; Rollator—Norge; Storabin—Crosley; Shelvador—Crosley; Eject-O-Cube—Westinghouse; Conservador—Fairbanks-Morse; Handy Jack—Westinghouse; Slo-Cycle—Stewart-Warner; Hydrocold—Sanitary; Crisper—Leonard; Scotch Yoke—Crosley; Thermo-Gauge—Frigidaire; Freez'r Shelf—Gibson; Kontanarrette—Stewart-Warner; Meter Miser—Frigidaire; Lifetime—Universal Cooler; Sav-A-Step—Stewart-Warner; Storaradrawer—Crosley; Monounit—Gibson; Feather-touch—Crosley; Textolite—General Electric; Down-Draft—Universal Cooler.

(Continued on page 42)



Around this great
**MAGIC MAGNET
SPEAKER**
**YOU CAN BUILD THE STRONGEST
SPEAKER SALES STORY IN YEARS**

Write Today for Complete Details
on the MAGIC MAGNET SPEAKER Line!

CINAUDAGRAPH CORPORATION • STAMFORD, CONN.
Speaker Division, Dept. "T"

CINAUDAGRAPH

DEALERS!

**SELL
PIONEER**

PORTABLE GAS-ENGINE GENERATING PLANT!



\$49.95
LIST
With A REAL
Profit For You!

It's easy to sell these sturdy, efficient power plants! They'll operate a complete lighting system and charge batteries and drive machinery by V-belt. Costs only 1c per hour to operate—built for constant heavy-duty service. Generous dealer profit-margin. **Marvelous sales opportunity!**

Mail the coupon TODAY!
**OPERATES ELECTRIC LIGHTING SYSTEM,
OPERATES RADIO AND AUTO BATTERIES,
CHARGES RADIO AT THE TOUCH OF A BUTTON!
DRIVES FARM POWER SAWS,
OPERATES A PUMP**

PIONEER GEN-E-MOTOR CORP.
462-T W. SUPERIOR ST., CHICAGO - Cable Address: SIMONTRICE, NEW YORK

MAIL THIS COUPON!
PIONEER GEN-E-MOTOR CORP.
462-T W. Superior St., Chicago, Ill., U.S.A.
Rush details PIONEER 6-Volt Gas Engine Generator

Sizes 6, 12V at
150 Walls; 6V
at 200 Walls;
12, 32, 110 V
at 250 Walls

Company _____
Address _____
By _____

RESULTS are proving 'CORONETS'

the biggest SALES IDEA the
tube industry has ever seen

You're probably asking yourself, "How do these Metal Tubes work in the old glass tube sets?" Space permits only a few comments:

"One 27 'CORONET' in detector socket of Crosley Model 77-1 increased volume and enabled owner to get stations he hadn't heard for a year."

"Installing one 24 'CORONET' one 80 'CORONET' and two 51 'CORONETS' in American Bosch Model 205 cut noise inset down 90 per cent."

"Replaced two-weeks old glass tubes on Model R-11 RCA with 'CORONETS.' For accurate check sent steady signal through set with oscillator using output meter connected to voice leads on speaker . . . noticeably increased output and improved reception."

*Names upon request.

'CORONETS' immediately put your tube business back on a profitable basis. Act now—write for details.

ARCTURUS

'CORONET' METAL TUBES



Arcturus Radio
Tube Co.
NEWARK, N. J.

COMPLETE ELECTRIC PLANTS



ONAN ALTERNATING
CURRENT PLANTS
OPERATE A.C. RADIO,
PUBLIC ADDRESS
SYSTEMS, SOUND CAR
EQUIPMENT, MOTION
PICTURES.

Can Be Used Anywhere

Supply Electricity for
Camps, Cottages, Farms,
Boats, Commercial Pur-
poses and places where
current is not available from power
companies. Will Operate Water System,
Refrigerator, Household Appliances.

Sizes to Suit Every Purpose

Built in sizes 350 to 50,000 watts,
\$110 and up. Supply 110 or 220 volt,
60 cycle, single or three phase cur-
rent. Operate on Gasoline, Gas or Dis-
tillate. Also 32 volt. D.C. Models. All
Models furnished complete, ready to run.

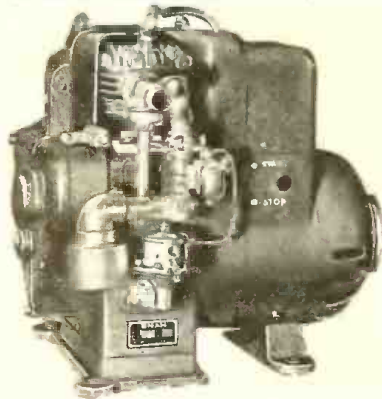

Write for details

D. W. ONAN & SONS
560 Royalston Ave. Minneapolis, Minn.

TODAY'S TRADE TOPICS

(Continued from page 41)

★ Henry Forster, president of Radio Speakers, Inc., which recently entered the speaker manufacturing field, has announced the appointment of George Howley as chief engineer of the company. Daylight factory headquarters have been established at 1338-1340 South Michigan Avenue, Chicago, and production is now in full swing on a complete line of permanent dynamic and electro dynamic speakers of all sizes.

★ Howard J. Sharle, general sales manager of General Household Utilities Corp., Chicago, manufacturer of Grunow radio and refrigeration products, announced this week the appointment of Paul B. (Tod) Reed, as advertising manager of the company. Mr. Reed has been identified with advertising and marketing activities for many years, having been associated with the P. P. Willis Corp., the J. Walter Thompson Company, and Frederick & Mitchell in Chicago. He was also advertising manager of the Earle C. Anthony Corp., distributor of Packard and Hudson automobiles on the Pacific Coast.

★ In anticipation of its Spring auto radio season, the Cornell-Dubilier Corporation, 4377 Bronx Boulevard, New York, has materially increased its production facilities for the manufacture of spark suppressors and ignition interference filter condensers.

★ New sales representative in five New York State southern tier counties for the Stromberg-Carlson Telephone Mfg. Co., is Lawrence Loveless, Bath, N. Y.

★ Stupakoff Laboratories have recently published a small card on which are mounted various component parts used in metal tube manufacturing, consisting of ceramic insulators, insulated filament wires, Kovar eyelets, Kovar copper lead-in wires and exhaust tubes. Copies of this card may be secured by writing the Stupakoff Laboratories, 6627 Hamilton Avenue, Pittsburgh, Pa.

★ T. A. Kenually, Philco's sales manager, has reported on the success of dealers using the plan of the Radio Institute of Audible Arts for "selling up" sets through increased sales emphasis on quality broadcast features. These dealers have actually raised their average unit of sale from ten to fifteen dollars.

★ From Atwater Kent headquarters comes the announcement that George L. Sammis, former vice-president and general sales manager of the Sunset Co., AK distributors of Portland, Oregon, has been appointed divisional sales manager for Wisconsin, Indiana, and Northern Illinois.

★ W. C. Hutchings, for many years active in merchandising circles in the talking machine and radio industries, has joined the sales staff of General Household Utilities Corp., Chicago.

★ G. Edwin Davis, sales representative for Stromberg Carlson formerly operating in the Utica-Albany, N. Y., area, has been transferred to the Rochester offices of the company.

★ Annual dealer "meeting and frolic" sponsored by the Iowa distributors, A. A. Schneiderhahn Co., was staged Mar. 17 at Des Moines. Program items for the 225 guests included an address by the Iowa State governor, floor show, banquet, and "complete stories" on various radio and refrigerator lines.

★ "Three full days of fun and fundamentals free" say the announcements from the Buccaneer Hotel at Galveston, Texas, where officials of the National Radio Service Ass'n are preparing for the Fourth Annual Texas Convention and Trade Show, May 24 to 26.

★ Fox West Coast theatres have been using Radiobars as giveaways with considerable success, according to reports from B. S. Tucker, Radiobar's sales manager. In the last 6 months, 400 of the instruments have been used by 100 of the show houses for that purpose.

**NATHANIEL
BALDWIN
CONTROLLED RESONANCE
SPEAKERS**

This ad pinned to your letterhead will bring you complete data on the great Baldwin line of Replacement Speakers.

CONSOLIDATED RADIO PRODUCTS CO. 361 W. SUPERIOR ST., CHICAGO
205 E. 42nd STREET, NEW YORK CITY

NEW THINGS FROM THE MANUFACTURERS

SIMPLIFIED TUBE TESTER

★ Direct reading tube tester with index system. Turning index wheel to proper tube number shows combination to be set up on switches—no reference to charts needed. English reading 4-inch meter—short and leakage tests—tests metal and low power transmitting tubes. Self-contained voltmeter—0/100/1,000 and ohmmeter. Dayrad model 20-C—net \$34.75.



Other new service items are vibrator tester, oscillator, tube testers, resonance indicator, set analyzer, cathode ray oscillograph, and multimeter combination. Radio Products Co., 125 Sunrise Pl., Dayton, Ohio—RADIO TODAY

MOBILE P.A. SYSTEM

★ P.A. system for 6-volt operation—20-watt class A output. Dual speed turntable plays up to 16-inch records. Crystal hand mike—two-channel mixer for mike and phono. Entire unit housed in compact case—designed to be set on front seat alongside driver, false bottom adjustable to angle of seat. Operadio Mfg. Co., St. Charles, Ill.—RADIO TODAY

6-TUBE AC-DC RADIO



★ All-wave AC-DC superhet having 3 metal and 3 glass tubes—range, 19-55, 63-190, 180-555 meters. Full-vision tuning dial—automatic volume control—variable tone control.

If. wavetrap and capacitive line filter. Walnut cabinet 16¼ x 13¼ x 8½ inches. Model 119—list \$39.95. Emerson Radio & Phonograph Co., 111 Eighth Ave., New York City—RADIO TODAY

5 AUTO RADIOS

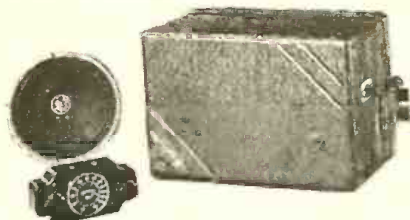

★ 1936 line of Atwater-Kent auto sets numbers 5 models. Available with glass or metal tubes—all-in-one units and 2-unit types. Control panel to match instrument panel of 33 leading car models. All are 6-tube sets. Model 136 illustrated—list \$56.50.

Other models: 126, single unit, \$49.90; 416, single unit, \$54.90; 446, 2-unit, \$54.90; 556, single unit, \$39.90. Atwater-Kent Mfg. Co., 4700 Wisahickon Ave., Philadelphia, Pa.—RADIO TODAY

AC AND AC-DC CONSOLES



★ Dual-wave 5-tube superhet—range 540-1,720, 2,100-7,000 kc. Large 6-inch colored dial. Tone control, AVC, 8-inch dynamic speaker for superior reception. Walnut cabinet 36 inches high. Model 108C—AC-DC, 110C—AC, list \$39.95. Corona Radio & Television Corp., 420 N. Sacramento Blvd., Chicago, Ill.—RADIO TODAY

AERIAL MAST KIT

★ Antenna mast kit consisting of two four-foot lengths of pipe finished in weather-proofed black with a coupling. Flange with three holes at top of mast for attaching guys and aerial. Also available is a special bracket for supporting pipe on roof—either flat or slanting types. Philco Radio & Television Corp., Tioga & C Sts., Philadelphia, Pa.—RADIO TODAY

ELECTRONIC WOBBULATOR

★ Frequency modulated oscillator for use with cathode ray oscillograph alignment of sets—covers frequencies from 100 to 30,000 kc. Calibration on airplane type dial. Frequency modulation entirely electronic—no moving parts—constant band width of 30 kc. Band limit beacons, perfect synchronism, selective modulation, spotted frequencies. Six tubes—8 x 11½ x 8½ inches. Model 180—net \$57.50. Triumph Mfg. Co., 4017 W. Lake St., Chicago, Ill.—RADIO TODAY

RADIO FREQUENCY CHOKES

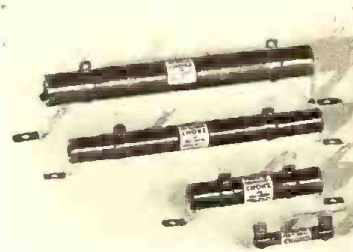

★ Single-layer wound radio frequency chokes for use in plate circuits of short-wave transmitters. Units wound on porcelain tubing and covered with insulating moisture-resisting compound which also holds wire in place. Four styles available covering frequencies from above 60,000 to 1,800. Ohmite Mfg. Co., 4835 W. Flourney St., Chicago, Ill.—RADIO TODAY

SERVICE AIDS

★ Repair products for servicemen are offered by General Cement Co., Rockford, Ill. New items are speaker repair cement, fibrelloid speaker shims, insulating and dipping varnish, non-slip compound for dial, grafoline contact lubricant, crystalizing lacquer in colors, color coding kit, dial colorings. Other similar items listed in catalog—RADIO TODAY

AC 5-TUBE DUAL WAVE

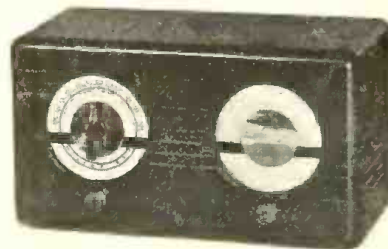

★ Compact AC dual-wave table set—range 75-550 meters. Superhet with 5 glass tubes—AVC and 3-gang condenser. Dynamic speaker—3-watt output. Model A-16 (illustrated) ebony finish with chromium trim—14 x 7½ x 8¼. List \$22.50. Model A-11 in walnut—\$19.95.

Other sets: A-1, 4T 2-volt table,

(To page 44)

NEW THINGS

(From page 43)

\$19.95; A-3, 6T 2-volt table, \$39.90; A-4 6T 2-volt cons., \$49.90; A-7, 7T 3-band table, \$49.90; A-8, 8T 3-band table, \$59.50; A-9, 5T 3-band table, \$36.95; A-10, 9T 3-band cons., \$79.90; A-12 6T 3-band cons., \$49.90; A-13, 8T 3-band cons., \$69.90; A-15, 6T AC-DC 2-band table, \$27.50. Wilcox-Gay Corp., Charlotte, Mich.—**RADIO TODAY**

TEST PROBE

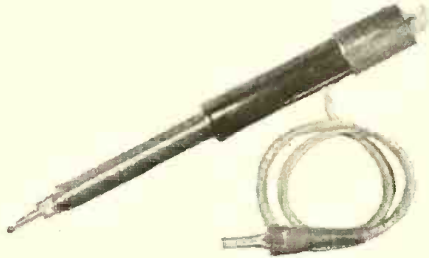

★ Probe for testing set voltages, resistors, condensers, continuity—shows open and shorted condensers. Equipped with ¼ watt neon lamp—dial light bulb is employed for continuity testing. Fiber tubing probe contains oil-processed condenser—has 20-inch flexible lead with alligator clip. Handprobe—net \$2.67. Burton-Rogers Co., 755 Boylston St., Boston, Mass.—**RADIO TODAY**

MODERNISTIC TABLE RADIO



★ Dual-wave AC-DC superhet—range 540-1,750, 5,500-18,000 kc.—5 tubes including ballast. Airplane 3-color dial—large dynamic speaker. Upright type chassis—rubber mounted tuning condenser. Modernistic cabinet—13¾ x 8½ x 6½ inches. Model 58—list \$29.95. Howard Radio Co., 1731 Belmont Ave., Chicago, Ill.—**RADIO TODAY**

LAMINATED ARMATURE SPEAKERS

★ New line of speakers employing Alnico magnetic alloy in a laminated armature construction—weight is unusually small. The 5-inch speaker weighs 7/8 lb.—list \$3. Also made in 6 and 8½ inch sizes listing \$3.50 and \$5. Arlab Mfg. Co., 1250 N. Paulina St., Chicago, Ill.—**RADIO TODAY**

6-METAL TUBE AUTO SETS



★ Superhet type receiver employing six metal tubes—iron-core input transformer for all antennas. Sensitivity of 1 microvolt. Drum type case of three pieces facilitates installation and servicing. Matched panel equipment for all cars. Model 266—single unit type with steering column controls—list \$52.95.

Other types—266SD 2 unit, \$57.95; 266SF 2 unit with header for Ford, \$52.95; 266SG 2 unit with header for G-M, \$54.95. Fada Radio & Electric Co., 30-20 Thomson Ave., Long Island City, N. Y.—**RADIO TODAY**

CHANGEABLE FIELD SPEAKER

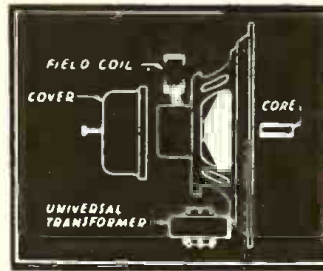

★ Replacement speaker with changeable field coil—easy to obtain field resistance needed. Self-adjusting units—cone remains centered. Universal transformer allows for matching of all output tubes. Available in 6, 8, and 11 inch models. Oxford-Tartak Radio Corp., 915 W. Van Buren St., Chicago, Ill.—**RADIO TODAY**

ALLOY FOR METAL TUBES

★ Kovar, patented alloy developed by Westinghouse, now supplied by Stupakoff Labs., Pittsburgh, Pa. Same coefficient of expansion as certain types of glass—seals perfectly making vacuum-tight container. Alloy supplied in wires, rods, sheets, strips, castings, and special shapes—suitable for use with hermetically sealed devices.—**RADIO TODAY**

BOOKCASE RADIO

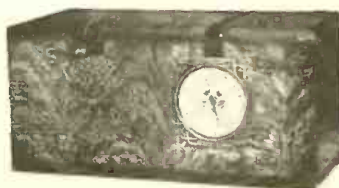

★ AC 3-band superheterodyne with six glass tubes—range 18-50, 66-187, 200-560 meters. Full-vision dial—3-gang variable condenser—automatic volume control. Cabinet of grained walnut veneer—19¼ x 9¾ x 8¾ inches. Lafayette model D-8—net \$19.95. Wholesale Radio Service Co., 100 Sixth Ave., New York City—**RADIO TODAY**

1936 AUTO RADIOS

★ New Philco auto sets feature instrument panel mounting, wide vision dials, and improved AVC circuits. Adjustable antenna systems and "T" bolt mounting provide easy installation. Specially designed filters and shielding eliminate need for suppressors. Other points are low current consumption, tone and sensitivity controls operating directly from streamlined control unit. Philco Radio & Television Corp., Tioga & C Sts., Phila. Pa.—**RADIO TODAY**

AUTO SET WITH CATHODE RAY TUNING

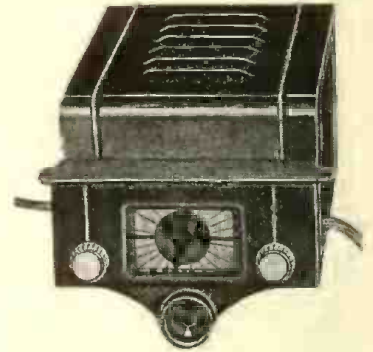

★ Six-tube auto radio with cathode ray tuning. Set mounts below instrument panel—direct tuning with full-vision dial. Tone control—suppressorless operation—output of 3 watts. Simplified installation—2 bolts. Model J-60. Automatic Radio Mfg. Co., 122 Brookline Ave., Boston, Mass.—**RADIO TODAY**

P.A. & TRANSMITTER RACKS

★ Newest products of Bud Radio, Inc., 1937 E. 55th St., Cleveland, Ohio, are relay racks, cabinet relay racks, relay rack panels, mounting brackets, and miscellaneous metal cabinets and chassis. Standard 6-foot rack, drilled and tapped—list \$18.50—**RADIO TODAY**

HEAVY DUTY RESISTORS

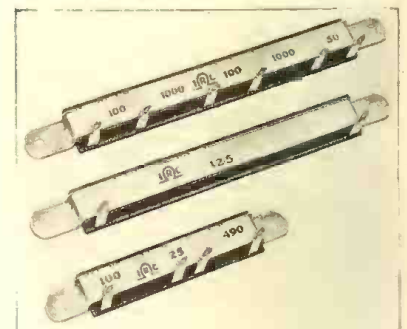

★ Wire-wound resistors enclosed in tough phenol compound capable of withstanding 170° C. and virtually impervious to moisture and salt spray. Insulation rated at 1,400 volts peak. Available from 6 to 20 watts—1½ to 5 inches long respectively. Resistances from 2 to 7,400 ohms per inch. Will stand prolonged 150 per cent overloads. Type MW. International Resistance Co., 401 N. Broad St., Philadelphia, Pa.—**RADIO TODAY**

LOW COST OSCILLOGRAPH

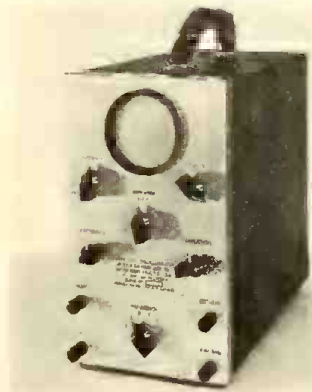

★ Inexpensive, lightweight cathode ray oscillograph designed for radio servicing. Has 3-inch tube—sensitivity of $\frac{3}{4}$ volt per inch with amplifier, 75 volts/inch without amp. Range of amplifier, 10 to 1,000,000 cycles—sweep fundamental, 10-150,000 cycles. Power supply employs voltage doubler circuit.—Synchronized sweep provision. Weight—18 lbs. Model 154—net \$74.50. Allen B. Dumont Labs., 542 Valley Rd., Upper Montclair, N. J.—RADIO TODAY

NEW RECEIVING TUBES

★ Recent tube types developed are: 6L6—metal tube beam type power output; 6N6—metal twin triode power output; 6R7—metal duodiode triode similar to 75; 6X5—full wave metal rectifier for auto sets; 1602—non-microphonic triode amplifier; 25A6-MG—metal cased output pentode.

Announced by Arceturus Radio Tube Co., 720 Frelinghuysen Ave., Newark, N. J.—metal for glass replacements with adapters, 25A6 for 43, 25Z6 for 25Z5.

By Ken-Rad Corp., Owensboro, Ky.—6L6.

By National Union Radio Corp., 570 Lexington Ave., New York City—25A6-MG.

By RCA Mfg. Co., Harrison, N. J.—6L6, 6X5, 1602.—RADIO TODAY

LOW-COST TUBE TESTER



★ Counter and portable tube tester for all tubes including new 5W4, 6L6, 6P7. English reading 5-inch meter—short and leakage tests. Separate line voltage meter. Selective switches insure against obsolescence. Separate tests of each section of

multi-purpose tube. Also has ohmmeter and condenser tester. Model 305C—net \$21.95. Radio City Products Co., 88 Park Pl., New York City—RADIO TODAY

RESISTOR CABINET

★ Storage cabinet for resistors—wood construction. Six drawers—each with 4 compartments. Offered free with purchase of 100 Wirt 1 watt resistors. Wirt Co., 5221 Greene St., Philadelphia, Pa.—RADIO TODAY

GRID BIAS CELL

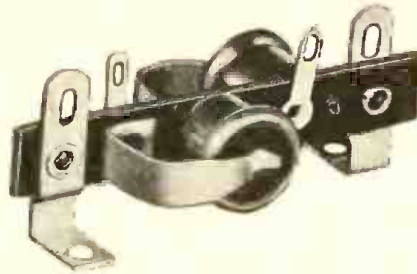

★ Potential cell designed to furnish grid bias to class A amplifier tubes. Cell furnishes fixed voltage, reduces number of circuit components, eliminates common-circuit coupling. Cell is $\frac{5}{8}$ in diameter by $1\frac{1}{32}$ —develops approximately 1 volt. Illustration shows dual mounting of 2 cells. P. R. Mallory & Co., Inc., Indianapolis, Ind.—RADIO TODAY

SPRING TYPE PLUG

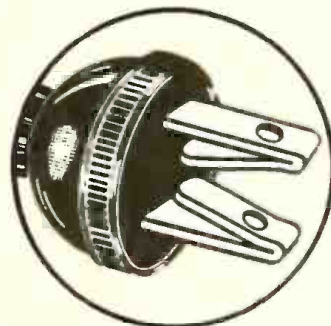

★ Radio and appliance electric plug employing a spring type of contacting prongs. Available in Bakelite and rubber styles with or without grip. Also there is a cube tap with spring action blades. Plugs eliminate noise caused by loose connections. List 5 and 10 cents. Allied Mercantile Co., 11 E. Runyon St., Newark, N. J.—RADIO TODAY

SPECIAL PURPOSE TUBES

★ Newest transmitting tubes are: 804—pentode amplifier with 40 watts plate dissipation; 805—hi-mu triode with 125 watts rating; 836—half wave vacuum rectifier.

Cathode ray tubes: 909—5-inch electrostatic vacuum, long persistence screen; 910—3-inch electrostatic vacuum, long persistence screen; 911—3-inch electrostatic vacuum, medium persistence screen.

Phototubes: 917—vacuum type; 918—gaseous type; 919—vacuum type. Above tubes manufactured by RCA Mfg. Co., Harrison, N. J.—RADIO TODAY

GLASS-TUBE AUTO RADIO

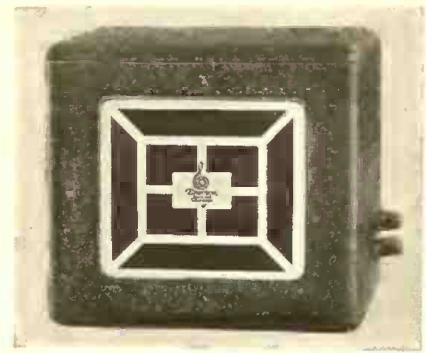

★ Auto radio with high audio output—audio AVC—variable mu pentode audio driver. Six glass tubes—2 dual purpose. Housed in die-cast case—6-inch dynamic speaker—non-synchronous vibrator. Model 2A. Emerson Radio & Phonograph Corp., 111 Eighth Ave., New York City—RADIO TODAY

PERMO-DYNAMIC SPEAKERS

★ Dynamic speakers employing Alnico and Alnico alloys in magnetic structure. Complete line of 5, 6, 8, 10, 12-inch models. Speakers up to 8 inches employ center pole type magnet—large models use ring type. Magnavox Co., Fort Wayne, Ind.—RADIO TODAY

PORTABLE RADIO

★ Six-tube AC-DC portable radio. Cabinet with cover resembles small traveling case. Full-vision tuning dial—furnished with built-in aerial wire. Model 557 G.

Other small sets including portable radio phonograph are available. Pathé Radio & Television Co., 1401 W. 11th St., Los Angeles, Calif.—RADIO TODAY

6-VOLT FARM RADIO

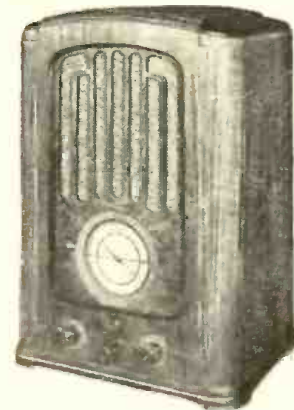

★ Five-tube (exclusive of rectifier) superhet for farm and export use. Standard range 545-18,800 kc.—long wave has additional band 750-2,100 meters. Dual speed tuning with full-vision dial. R-f. amplifier on all bands—diode detection—pentode output of $\frac{3}{4}$ watt. Series 250. Pilot Radio Corp., 37-06 36th St., Long Island City, N. Y.—RADIO TODAY

FOR RADIO-REFRIGERATOR DEALERS

★ **PUSHOVERS** by the thousand should show up among the refrigerator prospects for the coming year, but dealers will need to adopt the new "box" language in order to do the best job of selling.

This spring when the manufacturers presented their new lines they made important additions to the already impressive list of mechanical features. Many of these features have special names; listed as exclusive or patented improvements they have appeared by the dozen. In some cases special trade names have been applied to the whole line.

It is to be hoped that dealers will hear about, look into, and appreciate all these angles on modern refrigeration. Further, it is important that dealers remember the manufacturer-origin of significant trade words. At this point it appears to be a big job.

For instance, how many of these can you identify with the name of the manufacturer:

- Thriftytype
- Len-A-Drawer
- Revolv-it
- Len-A-Door
- Koldchest

- Baskador
- Pelco
- Baskadrawer
- Antifrost Clock
- Shelvatray
- Carrene
- Shelvabasket
- Touch-latch
- Rollator
- Storabin
- Shelvador
- Eject-O-Cube
- Conservador
- Handy Jack
- Slo-Cycle
- Hydrocold
- Crisper
- Scotch Yoke
- Thermo-Gauge
- Freez'r Shelf
- Kontanette
- Meter Miser
- Lifetime
- Sav-A-Step
- Storadrawer
- Monounit
- Feather-touch
- Textolite
- Down-Draft

Turn to page 41 for answers.



A perfect pair for year-round merchandising — radios and refrigerators. Latter is being plugged in a combination offer by this New Jersey dealer, who figures out similar timely stunts to feature his radio sets.

★ Bluefield Supply Co., Bluefield, West Virginia, are new distributors for Hotpoint refrigerators; also Clark Hardware and Furniture Co., who operate 7 retail stores in the area, have signed up to handle Hotpoint exclusively. Managers of all these stores were recently called into a huddle by Erle F. Morford, Hotpoint's divisional representative, who outlined the year's campaign.

★ Fairbanks-Morse has announced a new 5-year warranty on both "B" and "C" line Conservadors, offered to retail customers at option and issued to them on payment of an additional \$5 within 30 days after the date of the retail sale. FM's regular one-year warranty remains in effect, but if the patron buys the new protection he gets a contract covering the pressure-imposing mechanism of the refrigerator for an additional four years. During these four years, dealers will be reimbursed by the factory at flat rates for the service named in the contracts.

★ The 5-year protection plan on all Crosley Shelvador "boxes," recently announced at an added charge of \$5 to the suggested list price, is not optional, as was stated by the Crosley Corp. in its original announcement.

★ New distributor for Fairbanks-Morse Conservador refrigerators in Maryland, District of Columbia, Virginia, and part of West Virginia, is the Doubleday-Hill Electric Co., with offices in Washington, D. C., and branch headquarters at Baltimore, Md.

Fairbanks-Morse has also announced appointment of the Mississippi Valley Furniture Co., Memphis, Tenn., and the Keith Simmons Co., Nashville, Tenn., as refrigerator distributors. Former company will cover central Tennessee area and adjacent counties in Kentucky; latter will serve dealers in western Tennessee and parts of Arkansas and Missouri.

★ From the Lincoln Sales Corp., Crosley distributor in Baltimore, comes a report from president C. Howard Buchwald that refrigerator sales for February of this year were 100 per cent over sales for the corresponding month in 1934. Report included the statement that radio sales also showed a substantial gain.

★ Frigidaire has issued notice of these appointments: Roy E. Smithson, manager, commercial products sales division; Lowell McCutcheon, manager, wholesale division; Virgil Hetzel, manager installation and service division.

★ Edward C. Mines Co., Crosley dealer of Hammond, Ind., reports unusual success with a local contest in which the company will award a Shelvador to the writer of the best 75-word statement on why the 1936 Crosley Shelvador is the most desirable refrigerator.

★ D. W. Moser, head of the Kansas City Norge distributing firm of Moser & Suor, Inc., has announced increases in his sales staff amounting to a 50 per cent expansion plan. Moser Co. has also re-organized its promotional technique.

★★★ World's Fastest Sales Growth

BECAUSE: *World's Most Beautiful Refrigerator*

**PLUS THIS MUCH MORE
IN A SHELVADOR!!**



**18 MODELS, 6 SIZES. PRICED FROM
\$99.50 TO \$214.95, INCLUDING
DELIVERY, INSTALLATION AND
FIVE-YEAR PROTECTION PLAN**

*All prices slightly higher in Florida, Texas,
Rocky Mountain states and West.*

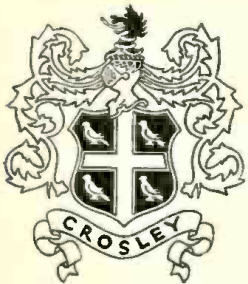

CROSLLEY

THE CROSLLEY RADIO CORPORATION, CINCINNATI - POWEL CROSLLEY, Jr., President

FACTS YOU NEED ABOUT NEW RADIO LINES FREE INFORMATION ON REQUEST

ANOTHER service by RADIO TODAY! Complete information on any of the products listed below may be obtained promptly by merely using the coupon and putting a circle around the number, or numbers, of the products in which you are interested. This service is offered to anyone who is engaged in the radio business.

SERVICING EQUIPMENT

1 Clough-Brengle Co., booklet "John Brown doesn't live here any more!" telling of the C-B Pay-As-You-Earn plan for obtaining servicing instruments.

2 Allen B. Dumont Labs, Inc., bulletin describing new low-cost cathode ray oscillograph.

3 Radio City Products Co., bulletin describing new Dependable analyzer, just announced, with emphasis on performance and price.

WIND CHARGERS

4 Wincharger Corporation, service manual to acquaint dealers and servicemen with business possibilities in the sale and installation of wind chargers.

SPEAKERS

5 Perm-O-Flux (Continental Motors Corporation), literature on new permanent magnet dynamic speaker employing new magnetic material.

6 Cinaudagraph Corp., complete details of Magic Magnet speaker line using new permanent magnet design and new magnetic alloy.

7 Oxford-Tartak Radio Corp., bulletin on improved type of dynamic replacement speaker with "changeable field."

8 Baldwin (Consolidated Radio Products Co.), data on the Baldwin line of replacement speakers.

COILS, I-F, R-F, ETC.

9 E. I. Guthman & Co., 4-page leaflet on numerous types of i-f, r-f and short wave coils and trimmer condensers.

PHONO-RADIO COMBINATIONS

10 Electrotone (Harris Mfg. Co.), complete catalog of phonograph and phono-radio combinations of the portable type. All-electric with push-pull amplifiers, 8-inch dynamic speakers, tone control, automatic or manual record changers.

GENERATORS

11 Pioneer Gen-E-Motor Corp., literature on portable gas-engine generators to furnish complete lighting system, charge batteries, drive power saws, operate pumps, etc.

12 D. W. Onan & Sons, catalog of complete electric plants embodying gas engine driven generators delivering 350 to 50,000 watts. Operate AC radio, P.A. and sound car equipment, water systems, refrigerators, etc.

PUBLIC ADDRESS

13 The Webster Co., catalog of portable and permanent sound systems and "A Short Course in Sound Engineering."

CAPACITORS

14 Cornell-Dubilier Corp., catalog 127 describing transmitting and industrial capacitors.

RESISTORS

15 Centralab Co., literature on volume controls, suppressors and other resistor types.

16 Ward Leonard Electric Co., bulletin and price list for servicemen, covering wire wound replacement resistors.

AUTO RADIO

17 Motorola (Galvin Mfg. Co.), direct-mail piece for use by distributors in dramatizing to dealers the selling points of new model Motorolas. Dash controls illustrated. Includes dealer-helps, demonstration display boards, mail pieces, etc.

18 RCA Manufacturing Co., details of dealers' promotion matter (posters, banners, folders, counter displays, easels, etc.).

19 Noblitt-Sparks Industries, booklet with charts and illustrations showing Arvin auto radio control units for practically any make of car. Also dealer helps.

20 Zenith Radio Corp., details of a dramatic, oversized poster on Zenith auto radio, for use in dealers' windows. Features a variety of control units fitting all cars.

21 Atwater Kent Mfg. Co., literature on latest A-K auto radio featuring arrow-light tuning and numerous advances in auto radio design.

BATTERIES

22 National Carbon Company, literature on Eveready air cell "A" batteries and layerbilt "B" batteries; containing suggestions on battery replacement sales.



● "It's got everything" is what wise dealers are saying about the new General Electric Radio window display shown on the opposite page. There's another wide-awake and popular sales promotion piece — a sales training film "IT'S GOT EVERYTHING" — every dealer and every retail salesman will want to see. Your G-E Radio Distributor will gladly arrange for a showing. Why not phone, now, for an early presentation?

● 1918 . . . Do you know — in this year General Electric perfected the high-vacuum tube? It was this development that made possible a new era in home reception.

● General Electric Radio Division strengthens its field force for the 1936 sales drive.

Appointed district radio sales managers: *B. C. Boue*, with headquarters in St. Louis, Mo., joined General Electric in 1909. *C. W. Griffin*, with headquarters in Los Angeles, Cal., joined General Electric in 1930. *H. W. Bennett*, with headquarters in Minneapolis, Mo., also joined General Electric in 1930.

Appointed district radio representatives: *John Klenke*, with headquarters in Portland, Ore., formerly sales manager of G-E Contracts Corporation. *R. A. Buescher*, with headquarters in Cincinnati, O., previously spent a number of years in radio retailing. *E. W. Sears*, with headquarters in Detroit, Mich., identified with the advertising and sales promotion fields for past fifteen years.

● 1923 . . . Do you know — this was the year General Electric developed the *Alexanderson System of Tuning*, which is now used in all tuned radio frequency circuits?

● These six radio retailers won cash awards in the G-E Radio Ad Manager contest for dealers: *Kansas City Power & Light Co.*, Kansas City, Mo., *Wurlitzer's*, Milwaukee, Wis., *L. A. Shattuck*, Clinton, Wis., *Hairy & Young*, Hartford, Conn., *Muller's*, Lake Charles, La., *Davis & Moore, Inc.*, East Cleveland, Ohio. Contestants were required to produce and run campaigns of newspaper ads, using material from the G-E Radio Ad Desk.

● 1924 . . . Do you know — it was during this year that General Electric created and developed the first cone loud speaker? This development made possible tone-true reproduction.

**WATCH
G-E RADIO IN 1936**

FOR FREE INFORMATION, FILL OUT THIS COUPON

Put circle around the number or numbers desired.

RADIO TODAY, 480 Lexington Avenue, New York.

1	2	3	4	5	6	7	8	9	10	11
12	13	14	15	16	17	18	19	20	21	22

Name

Name of Company

Street City State

Title or position



It's Got Everything!

A NEW General Electric WINDOW DISPLAY

The G-E Radio Bandmaster goes 'round and 'round pointing out all the features that make sales. Cash registers will ring with the song of profits when the Bandmaster goes into action.

Here's a display that is extremely smart, chock full of real customer appeal. A masterpiece in dramatic selling, so out of the ordinary it strikes a new keynote in selling "right from the window."

Radio dealers who take full advantage of the series of unusually striking sales promotion pieces offered by General Electric will find a new interest and enthusiasm injected into the business of increased turnover, volume sales and substantial profits.

Memo:-

Be sure to get complete information about this display and the General Electric Franchised Dealer plan. See your nearest G-E Radio Distributor, or write to General Electric Company, Radio Division, Bridgeport, Connecticut

GENERAL ELECTRIC

The Original Metal-tube Radio

APPLIANCE AND MERCHANDISE DEPARTMENT, GENERAL ELECTRIC COMPANY, BRIDGEPORT, CONN.

MAKE PROFITS that "STICK"

Tie-In Your Selling Effort NOW
with Today's Fastest Moving Line

Motorola

America's Finest **AUTO RADIO**

Alert Dealers and Service Men know Motorola to be the fastest selling, most profitable line they handle. Here are a few of the many reasons why: Outstanding Listening Quality: Trouble-Free Performance: Unrivalled Popular Acceptance: Powerful National and Point-of-Purchase Advertising: New Selling Features

MOTOROLA IS AGAIN A YEAR AHEAD

MATCHES THE DASH OF ALL CARS

Fits Perfectly and Harmoniously . . . Overhead Ear-Level Speakers Where Required.

ONLY MOTOROLA HAS THE "MAGIC ELIMINODE"

Newly Improved . . . This Patented Feature Guarantees Motor-Noise-Free Reception . . . Positively NO SPARK PLUG SUPPRESSORS.

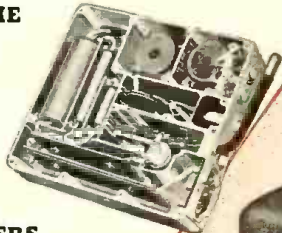

MATCHED TWIN SPEAKERS

Give even distribution of sound to passengers in both rear and front seats. For combined Under-Cowl and Overhead Installation—or else Combined Under-Cowl and Rear Seat Installation.

ADJUSTABLE ANTENNA SYSTEM

"Series-Fed" Antenna System—Adjustable for Peak Performance Using Under-Car or Roof Aerial.

"GOLDEN VOICE" Motorola

The most remarkable auto radio ever built. Amplified Delay (not quench) Automatic Volume Control. Full Variable Tone Control. Sensitivity Control. Breath-taking life-like radio reception . . . Complete.



\$89.50

10 All-Metal Tubes
10 "Golden Voice" Speaker



**MODEL "50"
6 TUBES**

Big Value Single Unit. Full Dynamic Built-in Speaker. 3-gang Tuning Condenser. Automatic Volume Control.

Complete **\$39.95**

**Model "60"
6 Tubes**



6"
**External
Speaker**

Supreme performance at a popular price. Uses 6-B-5 "Booster" High Power Output Tube. 6" Full Dynamic Speaker. Automatic Volume Control. Tone Control . . . Complete. With Optional 8" Speaker, List \$54.95

\$49.95

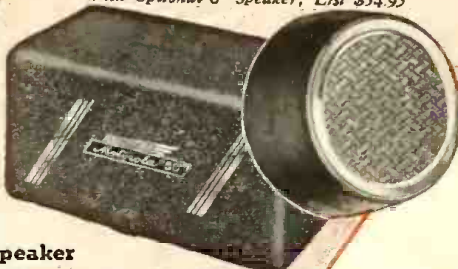

**Model "80"
8 Tubes
8" External Speaker**

Metal and Double Sealed Metal-Clad Tubes. Perfected Automatic Volume Control. Full Variable Tone Control. Uses two 6-N-6 "Booster" High Power Output Tubes . . . Complete

\$67.50

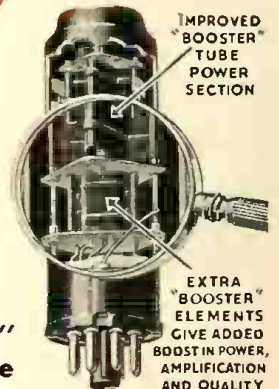

IMPROVED
"BOOSTER"
TUBE
POWER
SECTION

EXTRA
"BOOSTER"
ELEMENTS
GIVE ADDED
BOOST IN POWER,
AMPLIFICATION
AND QUALITY

**New "Booster"
Tubes Give
Super Power**

A basic development embodying a new principle in circuit design that boosts power, amplification and quality . . . Plenty of volume to fill car at highest speeds . . . Unmatchable radio reception with Studio Fidelity of Tone.

Installs on "Jiffy" Mounting Bracket

Compact . . . Installs Over Steering Post—Easier Than Ever Before . . . Plug-in Chassis.

ASK YOUR COMMUNITY MOTOROLA DISTRIBUTOR FOR DETAILS
GALVIN MFG. CORPORATION • CHICAGO